

# PERSAX<sup>®</sup>

siente el espacio



## TARIFA DE PRECIOS **DECORACIÓN**

CORTINAS ENROLLABLES · VERTICALES  
PANEL DESLIZANTE · SCREEN ZIP

TARIFA 2017

## INTRODUCCIÓN

Actualmente, la Enrollable es el modelo de cortina, más solicitado por el consumidor. Esta es la razón, por la que PERSAX<sup>®</sup> ha desarrollado un espectacular catálogo de tejidos, que cubre además de todas las exigencias técnicas y de calidad, las necesidades decorativas de los clientes más exigentes.

Disponemos de tejidos Screen de fibra de vidrio con PVC y Screen de poliéster con PVC, con diferentes factores de apertura. Tejidos trevira, tejidos 100% poliéster y tejidos opacos en diferentes calidades y acabados. Con todo ello somos capaces de dar solución a las exigencias más altas, en temas como la **calidad medioambiental**, ahorro energético y confort visual.

Disponemos de sistemas con eje de aluminio de diámetro 25, 43, 58 y 80 mm, con accionamiento a cadena, muelle, manivela y motor, que nos permiten fabricar con la máxima calidad y los mejores acabados del mercado.

Nuestra gran variedad de tejidos y colores, así como la posibilidad de personalizar su cortina enrollable con imágenes en impresión digital, le ayudarán a encontrar siempre lo que usted busca.



## MEDIDAS MÁXIMAS Y MÍNIMAS A FABRICAR







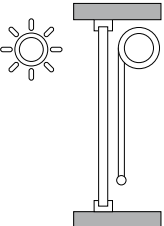
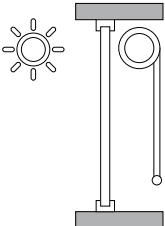



EJE	ACCIONAMIENTO	ANCHO MÍNIMO	ANCHO MÁXIMO	ALTO MÍNIMO	ALTO MÁXIMO
Ø25	Cadena	15 cm <sup>(1)</sup>	Según límite del tejido (ver tablas página 13)	Sin mínimos	Según los límites de los sistemas de accionamientos y los tejidos
	Muelle	60 cm			
Ø43	Cadena	15 cm <sup>(1)</sup>			
	Motor	Mecánico: 55 cm / Radio: 60 cm			
Ø58	Cadena / Manivela	15 cm <sup>(1)</sup>			
	Motor	Mecánico: 66 cm / Radio: 80 cm			
Ø80	Manivela	15 cm <sup>(1)</sup>			
	Motor	Mecánico: 66 cm / Radio: 80 cm			

(1) Para cortinas de ancho inferior a 80 cm, el alto máximo será 2,5 veces el ancho.

## DATOS NECESARIOS PARA REALIZAR UN PEDIDO (1)

ARTÍCULO	TEJIDOS TÉCNICOS	TEJIDOS DECORATIVOS	TEJIDOS OPACOS
	Referencia Color	Referencia Color	Referencia Color
MEDIDAS	Ancho X Alto		
LADO MANDO	Izquierda		Derecha
ENROLLAMIENTO	INTERIOR 	EXTERIOR <b>ESTANDAR</b> 	

**DATOS NECESARIOS PARA REALIZAR UN PEDIDO (2)**

EJE	SOPORTES APLICABLES	SOPORTE CENTRAL	GUIADO A CABLE	ACCIONAMIENTOS	
ø25	40	-	-	CADENA 1:1 	MUELLE 
ø43 ESTANDAR	40 ESTANDAR	●	●	CADENA 1:1 	MOTOR (pag.10) 
	55	●	●	CADENA 1:3  ESTANDAR	
ø58	55 Accionamiento Cadena o Motor	●	●	CADENA 1:3 	MANIVELA (pag. 12) 
	80 Universal	-	●	CADENA 1:4  SOLO SOP 55 1,00 1,50 2,00 2,50 3,00 CADENA CERRADA	
ø80	80 Universal	-	●		MANIVELA (pag. 12) 
					MOTOR (pag.10) 

**ALTO DE MANDOS ESTÁNDAR**

Hasta 1,50 m	5 cm menos
Entre 1,50 y 2,80 m	1,50 m
Más de 2,80 m	1 m menos

**MEDIDAS SOPORTES**

SOPORTE 40	SOPORTE 55	SOPORTE 80 UNIVERSAL
		

**LÍMITE DE PESOS EN FUNCIÓN DEL MECANISMO**

MECANISMO	EJE ø25	EJE ø43	EJE ø58	EJE ø80
<b>MUELLE</b>	Hasta 2,3 Kg	-	-	
<b>CADENA 1:1</b>	Hasta 2,3 Kg	Hasta 3 Kg	-	-
<b>CADENA 1:3</b>	-	Hasta 5 Kg	Hasta 4,5 Kg	-
<b>CADENA 1:4</b>	-	-	Hasta 7,5 Kg (cadena cerrada obligatoria)	-
<b>MANIVELA</b>	-	-	Sin Límite	Sin Límite
<b>MOTOR</b>	-	Sin Límite	Sin Límite	Sin Límite



**TERMINACIONES Y COLORES DISPONIBLES**

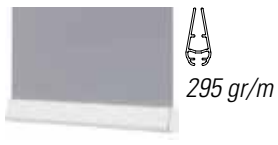

GOTA ALUMINIO VISTO

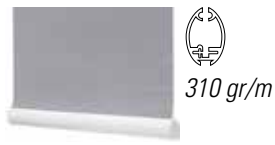

OVALADO ALUMINIO VISTO

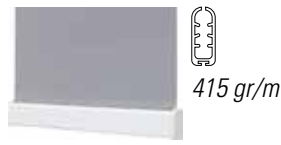

PLANO ALUMINIO VISTO



REDONDO ALUMINIO Ø18 EMBOLSADO

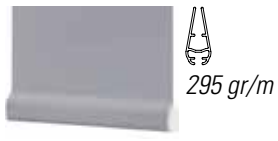

GOTA ALUMINIO EMBOLSADO



OVALADO ALUMINIO EMBOLSADO

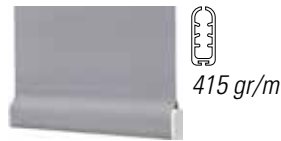

PLANO ALUMINIO EMBOLSADO

*\*Perfil terminal redondo también válido para sistema guiado cable, o guía ventilada y cuando necesitamos añadir peso a una cortina. Única opción siempre embolsado.*



BLANCO  
ESTANDAR



BEIGE



GRIS



NEGRO

**DESCUENTOS DE MEDIDA DEL TEJIDO EN CORTINA ENROLLABLE**

El ancho de la cortina será igual al **ancho del tejido + los valores de las tablas de descuentos**

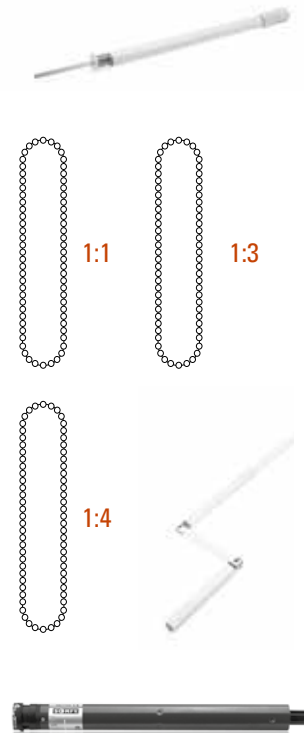
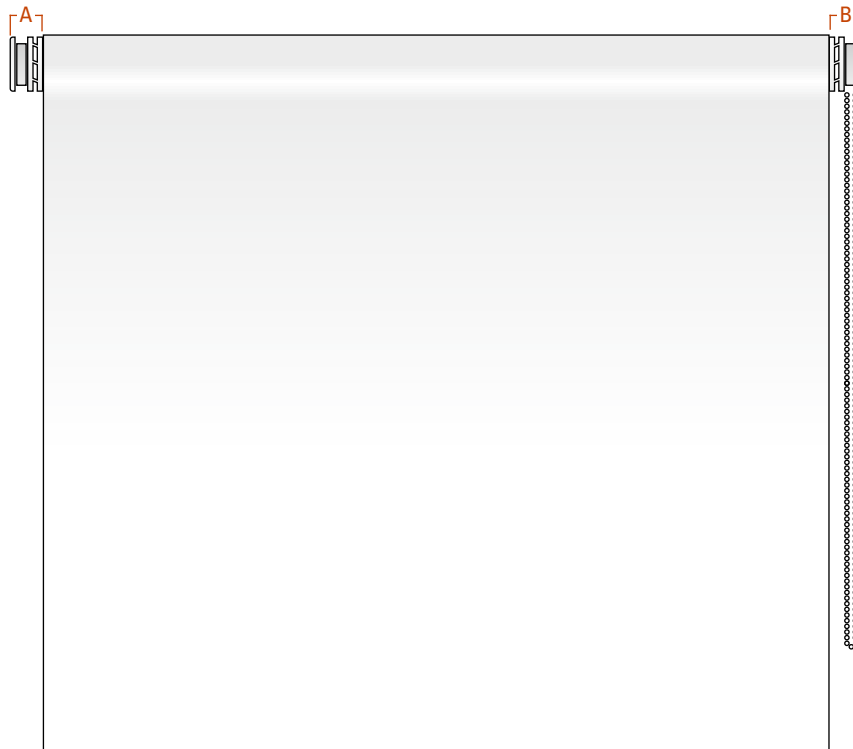

**TABLA DE DESCUENTOS**

ACCIONAMIENTO EJE	MUELLE		CADENA 1:1		CADENA 1:3		CADENA 1:4		MANIVELA		MOTOR	
	A	B	A	B	A	B	A	B	A	B	A	B
<b>ø25</b>	17 mm	18 mm	17 mm	22 mm	-	-	-	-	-	-	-	-
<b>ø43</b>	-	-	17 mm	22 mm	17 mm	22 mm	-	-	-	-	17 mm	23 mm
<b>ø58</b>	-	-	-	-	17 mm	23 mm	22 mm	25 mm	28 mm	36 mm	17 mm	25 mm
<b>ø80</b>	-	-	-	-	-	-	-	-	28 mm	36 mm	28 mm	27 mm

## DESCUENTOS DE MEDIDA DEL TEJIDO EN DOBLE CORTINA ENROLLABLE

**OPCIÓN 1.** DOS CORTINAS CON UN SOLO MANDO. SE ACCIONAN A LA VEZ.

**OPCIÓN 2.** DOS CORTINAS, CADA UNA CON SU MANDO. SE ACCIONAN DE MANERA INDEPENDIENTE

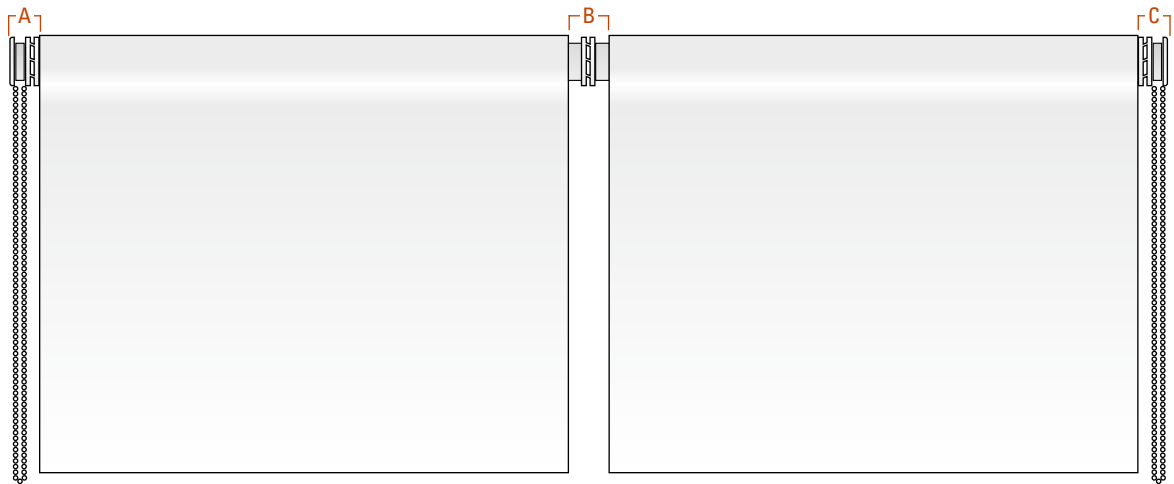

### TABLA DE DESCUENTOS OPCIÓN 1 Y OPCIÓN 2

ACCIONAMIENTO		CADENA 1:1			CADENA 1:3			MOTOR		
		A	B	C	A	B	C	A	B	C
1	ø43 mm	17 mm	20 mm	22 mm	17 mm	20 mm	22 mm	17 mm	20 mm	23 mm
	ø58 mm	-	-	-	17 mm	20 mm	23 mm	17 mm	20 mm	23 mm
2	ø43 mm	22 mm	20 mm	22 mm	22 mm	20 mm	22 mm	23 mm	20 mm	23 mm
	ø58 mm	-	-	-	23 mm	20 mm	23 mm	23 mm	20 mm	23 mm

### ACCESORIOS SISTEMA DOBLE (Sin cargo. Incluidos en el precio de la cortina)

CONTERA D-43 HEMBRA	SOPORTE CENTRAL 40/55	CONTERA D-43 MACHO
		
Cod. 182162		

### INFORMACIÓN SOBRE TEJIDOS INVERTIDOS Y SOLDADURAS

Con el objetivo de mantener el nivel de calidad en nuestros productos, PERSAX® confecciona sus cortinas cortando los tejidos en el sentido de la urdimbre de los mismos. Esto significa que el ancho del tejido, siempre es el máximo ancho de la cortina. También significa que el aprovechamiento del tejido sea menor, pero con ello conseguimos un mejor funcionamiento y estéticamente obtenemos los mejores resultados.

Cuando tenemos que invertir un tejido, para conseguir un ancho mayor, estamos desvirtuando la esencia del tejido. En PERSAX® no somos partidarios de esta opción, porque nunca vamos a conseguir los mismos resultados que con el tejido en sentido urdimbre, por eso ofrecemos la posibilidad de utilizar soportes centrales, que permiten dejar el mínimo espacio entre cortina y cortina. No obstante si se insiste en la opción de girar el tejido, incluso soldarlo para conseguir medidas máximas en una sola cortina, el cliente debe saber que aunque el resultado sea de máxima seguridad, porque PERSAX® dispone de la tecnología más avanzada para la confección, siempre pueden aparecer ondulaciones en los tejidos, debido a las tensiones que pueden provocar las soldaduras o el giro del tejido. La soldadura se hará siempre en horizontal y se pondrá en la parte superior de la cortina salvo que el cliente indique lo contrario. PERSAX® nunca aconseja esta opción.



**COMPONENTES - CORTINA ENROLLABLE**

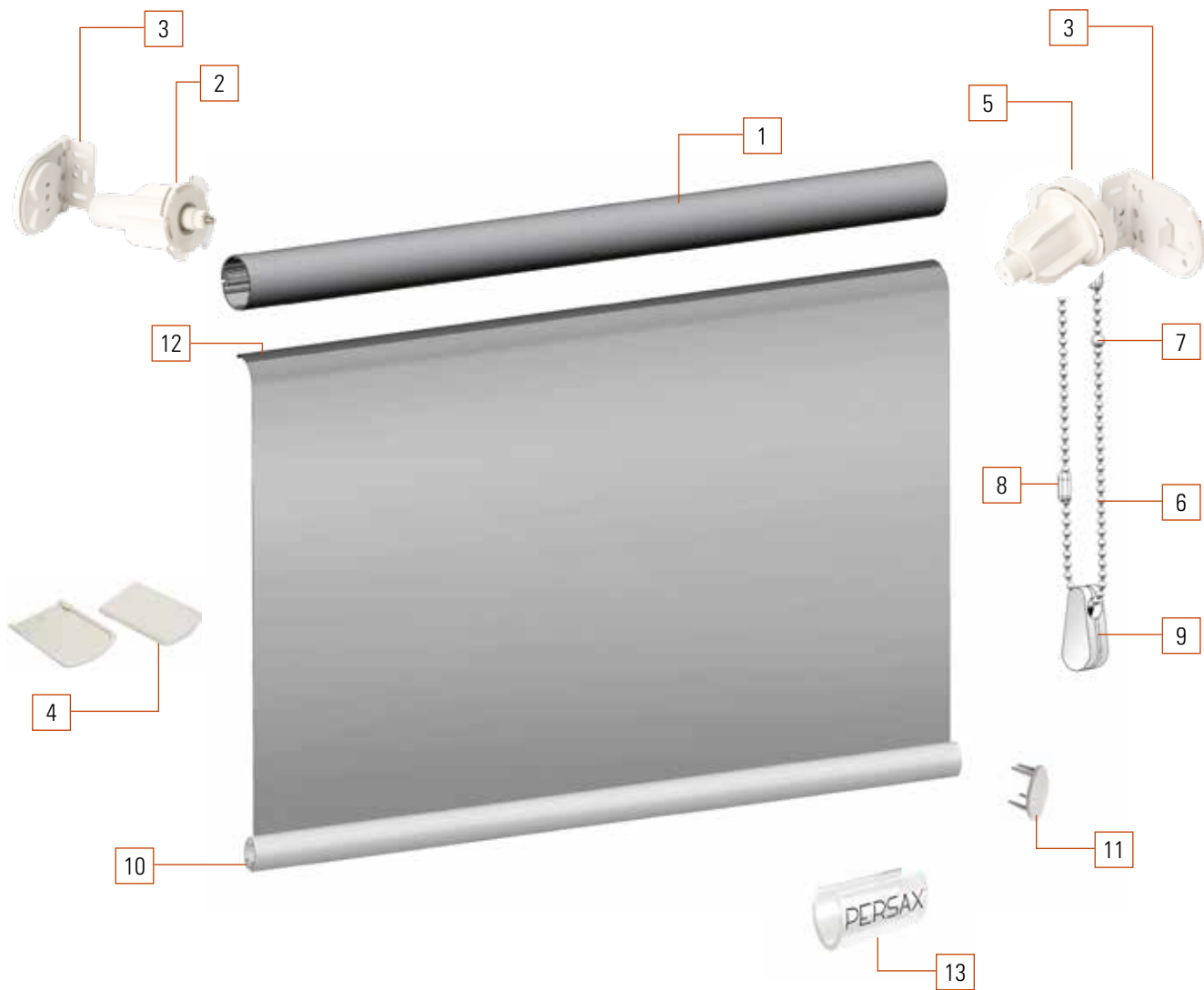

Nº	COMPONENTE	CÓDIGO
1	Eje aluminio	382046
2	Contera perno retráctil	182170
3	Juego de soportes	182181
4	Juego tapas soportes	182184
5	Mecanismo a cadena	182177
6	Cadena mando PVC	482001
7	Tope cadena mando	182030

Nº	COMPONENTE	CÓDIGO
8	Unión cadena mando	182029
9	Pomo perita estor enrollable	182031
10	Remate de aluminio	482047
11	Tapa remate de aluminio	182187
12	Lengüeta termosoldada	482046
13	Grapa clip marca	182173

## LOS INCREMENTOS

### SISTEMA DE ACERO INOXIDABLE

REPRESENTACIÓN	CÓDIGO	DESCRIPCIÓN	PRECIO €/ und. - m	INCREMENTO €/UND CORTINA COMPLETA
	182154	JGO. TAPAS SOPORTES INOX 40	9,64	72,85
	182155	JGO. TAPAS SOPORTES INOX 55	10,25	
	182156	JGO. TAPAS CUBRE TORNILLOS INOX 40/55	9,05	
	182148	JGO. JUEGO SOPORTES INOX 40	10,35	
	182149	JGO. JUEGO SOPORTES INOX 55	11,36	
	182143	CONTERA DE 43 PERNO RETRÁCTIL INOX	4,88	
	182144	MECANISMO CADENA INOX EJE 43	9,72	
	482029	REMATE ALUMINIO 15 MM ESTOR INOX	10,55	
	182003	TAPON REMATE 15 MM ESTOR INOX	1,70	
	482048	CADENA MANDO METALICA INOX	2,64	

### ARTÍCULOS

SEGURIDAD INFANTIL	CÓDIGO	DESCRIPCIÓN	PRECIO €/ und.
	119055	SOPORTE RECOGEDOR CORDÓN	3,10
	119059	TENSOR CORDÓN / CADENA	3,40

### INCREMENTOS

DESCRIPCIÓN	CÓDIGO	INCREMENTO €/UND CORTINA COMPLETA
ACCIONAMIENTO A CADENA R1:3 EJE 43/58	882019	4,50
ACCIONAMIENTO A MUELLE EJE 25	882023	18,75
SOLDADURAS EN TEJIDOS APROPIADOS	882026	12,50
REFUERZOS LATERALES EN TEJIDOS APROPIADOS	882024	18,00
CADENA METÁLICA	882018	10,50







**INCREMENTOS POR MOTORIZACIÓN**



**MOTOR PULSADOR**

	MOTOR	CÓDIGO	PAR NOMINAL	VELOCIDAD	TENSIÓN	POTENCIA	DECIBELIOS	PRECIO €
	MERCURE 3/30	124601	3 Nm	30 r.p.m	230 V AC	80 W	50 dBA	145,50
	ARIANE 6/32	124608	6 Nm	32 r.p.m		120 W	52 dBA	199,90
	JET 10/32	124426	10 Nm			160W	54 dBA	249,60

**MOTOR VÍA RADIO RTS (los precios no incluyen el emisor)**

	MOTOR	CÓDIGO	PAR NOMINAL	VELOCIDAD	TENSIÓN	POTENCIA	DECIBELIOS	PRECIO €
	ALTUS 40 RTS 3/30	124603	3 Nm	30 r.p.m	230 V AC	80 W	52 dBA	324,00
	ALTUS 50 RTS 6/32	124609	6 Nm	32 r.p.m		120 W		338,40
	ALTUS 50 RTS 10/32	124570	10 Nm			160W	54 dBA	391,15

**MOTOR SERIE  (para sistema TaHoma®)**

	MOTOR	CÓDIGO	PAR NOMINAL	VELOCIDAD	TENSIÓN	POTENCIA	DECIBELIOS	PRECIO €
	SUNEA SCREEN IO RH 3/30	1241065	3W Nm	30 r.p.m	230 V AC	80 W	50 dBA	324,00
	SUNEA SCREEN IO RH 6/32	124891	6 Nm	32 r.p.m		120 W	52 dBA	332,80
	SUNEA SCREEN IO RH 10/32	1241064	10 Nm			160 W	54 dBA	341,25

**ÁBACOS DE SELECCIÓN DE MOTOR**

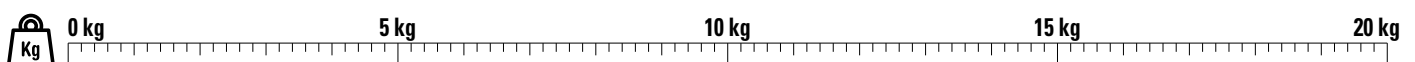





EJE ø43	3/30	
EJE ø58		6/32
EJE ø80	6/32	10/32





**ACCESORIOS PARA MOTORIZACIÓN**

REPRESENTACIÓN	CÓDIGO	DESCRIPCIÓN	PRECIO € / und.
	124031	EMISOR 1 CANAL. TELIS	72,00
	124033	EMISOR 4 CANAL. TELIS	123,70
	124698	EMISOR 16 CANAL. TELIS	298,80
	124811	EMISOR Situio iO 1 CANAL	86,20
	135022	EMISOR Situio iO 4 CANAL	132,55
	124093	CENTRALITA TAHOMA	590,00

somfy®

Disponemos de toda la gama SOMFY, consulte precios



**Interfaz intuitiva**  
3 menús intuitivos y sencillos

- MIS ESCENARIOS  
Crea instantes de vida conectados
- MI AGENDA  
Planifica tus equipos según tu ritmo
- SMART  
Programa funciones avanzadas

**ACCESOS Y SEGURIDAD**

**AHORRO DE ENERGÍA**

**EXTERIOR**

**ILUMINACIÓN**

**VENTANAS Y CERRAMIENTOS**

**Evolutivo**  
Compatible con una amplia gama de equipos Somfy y marcas asociadas.

**El sistema TaHoma se compone de dos partes:**  
El dispositivo TaHoma conectado a tu router de Internet y a la corriente. La aplicación para el móvil, tableta u ordenador de descarga gratuita.

Tahoma es la primera solución para el hogar conectado con certificación SYSS.

**somfy**  
TaHoma

App Store | Google Play































































**INCREMENTOS - ACCIONAMIENTO A MANIVELA**

REPRESENTACIÓN	DESCRIPCIÓN	CODIGO	PRECIO €/ und.	SISTEMA	INCREMENTO €/UND CORTINA COMPLETA
	CONTERA D-58 EJE CUADRADO	182172	3,60	EJE 58 Y EJE 80	58,25 + manivela
	CONTERA 58 PERNO RETRÁCTIL	182171	4,96		
	SNODO	111578	24,30		
	MECANISMO CARDAN	111267	26,50		
	ARO CUBRETUBO 58	182167	2,57		
	ARO CUBRETUBO 80	182168	2,92		
	ANILLO FIJACIÓN MT12 DE MANIVELA A SNODO	111580	1,60		

REPRESENTACIÓN	DESCRIPCIÓN	CÓDIGO	PRECIO €/ und.
	MANIVELA CARDAN ARTICULADA MT12 1,40 <b>ESTANDAR</b>	111475	21,60
	MANIVELA CARDAN ARTICULADA MT12 1,60	111269	23,10
	MANIVELA CARDAN ARTICULADA MT12 2,20	111474	29,10

REPRESENTACIÓN	DESCRIPCIÓN	CODIGO	PRECIO €/ und.
	REDUCCIÓN MAGNÉTICA SNODO MT12 (para manivela desmontable)	111722	19,60
	SNODO MT12 C-6 L330 90° TRASPASAMUROS	111272	23,85
	PINZA MANIVELA CARDAN MT12	11270	1,20

**TEJIDOS CORTINA ENROLLABLE**

	GAMA	COMP.	 gr/m <sup>2</sup>	ANCHO	CARACTERÍSTICAS				CORTINA COMPLETA	SÓLO TEJIDO	
									TARIFA	CORTADO	CONFECCIONADO
<b>TEJIDOS EXCELLENCE</b>	BLACK-WHITE	100% PES	200	230 cm					<b>5</b>	28.26	32.50
	METAL LINE	PE/Luvex	120	280 cm					<b>4</b>	32.52	37.40
	AMARANT	100% PES	80	280 cm					<b>4</b>	24.78	28.50
	P. STITCH	Trevira CS	200	230 cm					<b>6</b>	56.52	65.00
	T. STITCH	100% PES	130	230 cm					<b>6</b>	56.52	65.00
<b>TEJIDOS DECORATIVOS</b>	TENDENCE	100% PES	130	230 cm					<b>2</b>	17.39	20.00
	JUNO	100% PES	160	230 cm					<b>2</b>	16.91	19.45
	CETUS	Trevira CS	140	230 cm					<b>2</b>	17.30	19.90
	CHEVRON	100% PES	240	230 cm					<b>3</b>	24.48	28.15
	JUPITER	Trevira CS	150	250 cm					<b>2</b>	19.04	21.90
	POLARIS	Trevira CS	200	230 cm					<b>1</b>	17.30	19.90
	MISSONI	100% PES	130	280 cm					<b>5</b>	35.65	41.00
	NATURA	Fibra. V / PVC	400	250 cm					<b>5</b>	35.04	40.30
	S-SCREEN	Fibra. V / PVC	630	310 cm					<b>6</b>	51.26	58.95
	CLASSIC	100% PES	220	300 cm					<b>1</b>	16.91	19.45
	RUSTIK	100% PES	180	300 cm					<b>1</b>	17.17	19.75
	SHANTUNG FR	100% PES	180	320 cm					<b>1</b>	14.57	16.75
<b>TEJIDOS OPACOS</b>	KARELLIS	100% PES	300	300 cm					<b>5</b>	33.04	38.00
	JUNO BLACK OUT	100% PES	280	230 cm					<b>3</b>	24.09	27.70
	TENDENCE BLACKOUT	100% PES	220	230 cm					<b>3</b>	26.09	30.00
	OPAC 487	Fibra. V / PVC	487	300 cm						<b>3</b>	29.13
<b>TEJIDOS TÉCNICOS</b>	SATINÉ 5500	Fibra. V / PVC	520	250 cm					<b>4</b>	33.04	38.00
	SPS-6053	PES / PVC	600	300 cm					<b>4</b>	29.57	34.00
	SPS-4155	PES / PVC	410	300 cm					<b>2</b>	16.52	19.00
	M-SCREEN 8505	Fibra. V / PVC	405	250 cm					<b>5</b>	34.04	39.15
	B-SCREEN 1%	Fibra. V / PVC	410	320 cm					<b>3</b>	24.17	27.80
	B-SCREEN 3%	Fibra. V / PVC	380	320 cm					<b>3</b>	23.26	26.75
	B-SCREEN 5%	Fibra. V / PVC	365	320 cm					<b>3</b>	21.96	25.25
	CETUS SIVER	Trevira CS	140	230 cm					<b>4</b>	27.39	31.50
	SUNSED	PES / PVC	420	300 cm					<b>4</b>	33.04	38.00
	POLIVISIÓN	100% PES	195	300 cm					<b>1</b>	16.91	19.45

\*Tanto en tejido confeccionado como cortado, mínimo a facturar 1,50 m<sup>2</sup>



**TARIFA CE-01**

**POLARIS, SHANTUNG FR, CLASSIC, RUSTIK, POLIVISION**

ANCHO ALTO	EJE	1,00	1,20	1,40	1,60	1,80	2,00	2,20	2,40	2,60	2,80	3,00	3,20
<b>1,00</b>	ø 25	76	83	-	-	-	-	-	-	-	-	-	-
	ø 43	77	84	91	98	105	112	119	126	-	-	-	-
	ø 58	128	137	146	154	163	172	181	189	189	197	206	214
	ø 80	114	125	135	146	157	167	178	188	190	200	210	220
<b>1,20</b>	ø 25	80	87	-	-	-	-	-	-	-	-	-	-
	ø 43	80	88	96	103	111	118	126	134	-	-	-	-
	ø 58	132	141	150	160	169	179	188	198	197	206	215	224
	ø 80	117	129	140	151	163	174	185	197	198	209	220	231
<b>1,40</b>	ø 25	83	91	-	-	-	-	-	-	-	-	-	-
	ø 43	84	92	100	109	117	125	134	142	-	-	-	-
	ø 58	135	145	155	165	175	185	196	206	206	215	225	234
	ø 80	121	133	145	157	169	181	193	205	207	218	229	241
<b>1,60</b>	ø 25	87	95	-	-	-	-	-	-	-	-	-	-
	ø 43	87	96	105	114	123	132	141	150	-	-	-	-
	ø 58	138	149	160	171	181	192	203	214	214	224	234	245
	ø 80	124	137	149	162	175	187	200	213	215	227	239	251
<b>1,80</b>	ø 25	90	99	-	-	-	-	-	-	-	-	-	-
	ø 43	90	100	110	119	129	139	148	158	-	-	-	-
	ø 58	142	153	165	176	188	199	210	222	222	233	244	255
	ø 80	128	141	154	168	181	194	208	221	223	236	249	261
<b>2,00</b>	ø 25	93	103	-	-	-	-	-	-	-	-	-	-
	ø 43	94	104	114	125	135	145	156	166	-	-	-	-
	ø 58	145	157	169	181	194	206	218	230	231	242	254	265
	ø 80	131	145	159	173	187	201	215	229	232	245	258	272
<b>2,20</b>	ø 43	97	108	119	130	141	152	163	174	-	-	-	-
	ø 58	148	161	174	187	200	212	225	238	239	251	263	276
	ø 80	134	149	164	178	193	208	222	237	240	254	268	282
<b>2,40</b>	ø 43	101	112	124	136	147	159	171	182	-	-	-	-
	ø 58	152	165	179	192	206	219	233	246	247	260	273	286
	ø 80	138	153	168	184	199	214	230	245	248	263	278	292
<b>2,60</b>	ø 43	104	116	129	141	153	166	178	191	-	-	-	-
	ø 58	155	169	184	198	212	226	240	254	256	269	283	296
	ø 80	141	157	173	189	205	221	237	253	257	272	287	303
<b>2,80</b>	ø 43	107	120	133	146	159	173	186	199	-	-	-	-
	ø 58	159	173	188	203	218	233	248	262	264	278	292	307
	ø 80	144	161	178	195	211	228	245	261	265	281	297	313
<b>3,00</b>	ø 43	111	124	138	152	166	179	193	207	-	-	-	-
	ø 58	162	177	193	208	224	240	255	271	272	287	302	317
	ø 80	148	165	183	200	217	235	252	270	273	290	307	323
<b>3,20</b>	ø 58	157	173	188	204	219	235	250	265	281	296	312	327
	ø 80	144	161	179	196	213	230	247	265	282	299	316	333
<b>3,40</b>	ø 58	161	177	193	209	225	241	257	273	289	305	321	337
	ø 80	147	165	183	201	219	237	255	272	290	308	326	344
<b>3,60</b>	ø 58	164	181	197	214	231	247	264	281	298	314	331	348
	ø 80	151	169	188	206	225	243	262	280	299	317	336	354
<b>3,80</b>	ø 58	167	184	202	219	236	254	271	289	306	323	341	358
	ø 80	154	173	192	211	230	250	269	288	307	326	345	364
<b>4,00</b>	ø 58	170	188	206	224	242	260	278	296	314	332	350	368
	ø 80	157	177	197	216	236	256	276	296	315	335	355	375



**TARIFA CE-02**

**CETUS, JUPITER, TENDENCE, JUNO, SCREEN SPS-4155**

\*Sólo tejidos apropiados y para altos superiores al ancho del tejido llevarán soldadura.

ANCHO ALTO	EJE	1,00	1,20	1,40	1,60	1,80	2,00	2,20	2,40	2,60	2,80	3,00	3,20*	3,40*	3,60*	3,80*	4,00*	4,20*	4,40*
<b>1,00</b>	ø 25	74	81	-	-	-	-	-	-	-	-	-	-	-	-	-	-	-	-
	ø 43	75	83	90	97	114	122	130	137	-	-	-	-	-	-	-	-	-	-
	ø 58	124	133	142	151	176	185	195	205	234	245	255	266	276	287	-	-	-	-
	ø 80	111	122	133	143	169	180	192	204	235	247	260	273	285	298	311	324	336	349
<b>1,20</b>	ø 25	79	86	-	-	-	-	-	-	-	-	-	-	-	-	-	-	-	-
	ø 43	79	87	95	102	121	130	138	147	-	-	-	-	-	-	-	-	-	-
	ø 58	128	138	147	157	183	193	204	214	245	257	268	279	291	302	-	-	-	-
	ø 80	115	126	138	149	176	188	201	213	246	259	273	286	300	314	327	341	354	368
<b>1,40</b>	ø 25	82	90	-	-	-	-	-	-	-	-	-	-	-	-	-	-	-	-
	ø 43	83	91	100	108	128	138	147	156	-	-	-	-	-	-	-	-	-	-
	ø 58	132	142	152	162	190	201	212	224	256	269	281	293	305	318	-	-	-	-
	ø 80	118	130	143	155	183	196	209	223	257	271	286	300	315	329	344	358	372	387
<b>1,60</b>	ø 25	86	94	-	-	-	-	-	-	-	-	-	-	-	-	-	-	-	-
	ø 43	86	95	105	114	135	145	156	166	-	-	-	-	-	-	-	-	-	-
	ø 58	135	146	157	168	197	209	221	233	267	281	294	307	320	333	-	-	-	-
	ø 80	122	135	148	160	190	204	218	232	268	283	299	314	329	344	360	375	390	406
<b>1,80</b>	ø 25	98	108	-	-	-	-	-	-	-	-	-	-	-	-	-	-	-	-
	ø 43	99	110	121	131	142	153	164	175	-	-	-	-	-	-	-	-	-	-
	ø 58	153	165	178	191	204	217	230	242	279	293	307	321	335	349	-	-	-	-
	ø 80	138	152	167	182	197	212	227	241	279	295	311	328	344	360	376	392	408	425
<b>2,00</b>	ø 25	102	113	-	-	-	-	-	-	-	-	-	-	-	-	-	-	-	-
	ø 43	103	114	126	138	149	161	173	185	-	-	-	-	-	-	-	-	-	-
	ø 58	156	170	184	197	211	225	238	252	290	305	319	334	349	364	-	-	-	-
	ø 80	142	157	173	188	204	220	235	251	290	307	324	341	358	375	392	409	426	443
<b>2,20</b>	ø 43	107	119	132	144	156	169	181	194	-	-	-	-	-	-	-	-	-	-
	ø 58	160	175	189	204	218	232	247	261	301	317	332	348	364	379	-	-	-	-
	ø 80	145	162	178	195	211	227	244	260	301	319	337	355	373	391	409	426	444	462
<b>2,40</b>	ø 43	110	124	137	150	164	177	190	203	-	-	-	-	-	-	-	-	-	-
	ø 58	164	180	195	210	225	240	256	271	312	328	345	362	378	395	-	-	-	-
	ø 80	149	167	184	201	218	235	252	270	312	331	350	369	387	406	425	444	462	481
<b>2,60</b>	ø 43	114	128	142	157	171	185	199	213	-	-	-	-	-	-	-	-	-	-
	ø 58	168	184	200	216	232	248	264	280	323	340	358	375	393	410	-	-	-	-
	ø 80	153	171	189	207	225	243	261	279	324	343	363	382	402	422	441	461	480	500
<b>2,80</b>	ø 43	118	133	148	163	178	193	207	222	-	-	-	-	-	-	-	-	-	-
	ø 58	172	189	206	222	239	256	273	290	334	352	371	389	407	426	-	-	-	-
	ø 80	157	176	195	213	232	251	270	288	335	355	376	396	416	437	457	478	498	519
<b>3,00</b>	ø 43	122	138	153	169	185	200	216	232	-	-	-	-	-	-	-	-	-	-
	ø 58	176	194	211	229	246	264	281	299	345	364	384	403	422	441	-	-	-	-
	ø 80	161	181	200	220	239	259	278	298	346	367	388	410	431	452	474	495	516	538
<b>3,20</b>	ø 58	196	216	236	256	276	296	316	336	356	376	396	416	436	456	-	-	-	-
	ø 80	180	202	224	246	268	290	313	335	357	379	401	423	446	468	490	512	534	556
<b>3,40</b>	ø 58	201	222	242	263	284	305	326	347	368	388	409	430	451	472	-	-	-	-
	ø 80	184	207	230	253	276	299	322	345	368	391	414	437	460	483	506	529	552	575
<b>3,60</b>	ø 58	205	227	248	270	292	314	335	357	379	400	422	444	466	487	-	-	-	-
	ø 80	188	212	236	260	284	308	331	355	379	403	427	451	475	499	522	546	570	594
<b>3,80</b>	ø 58	209	232	254	277	300	322	345	367	390	412	435	458	480	503	-	-	-	-
	ø 80	192	217	242	267	291	316	341	366	390	415	440	465	489	514	539	563	588	613
<b>4,00</b>	ø 58	214	237	260	284	307	331	354	378	401	424	448	471	495	518	-	-	-	-
	ø 80	197	222	248	274	299	325	350	376	401	427	453	478	504	529	555	581	606	632





**TARIFA CE-03**

CHEVRON, JUNO BLACKOUT, TENDENCE BLACKOUT, OPAC 487, B-SCREEN 1% - 3% - 5%

\*Sólo tejidos apropiados y para altos superiores al ancho del tejido llevarán soldadura.

ANCHO ALTO	EJE	1,00	1,20	1,40	1,60	1,80	2,00	2,20	2,40	2,60	2,80	3,00	3,20*	3,40*	3,60*	3,80*	4,00*	4,20*	4,40*
<b>1,00</b>	Ø 25	82	91	-	-	-	-	-	-	-	-	-	-	-	-	-	-	-	-
	Ø 43	84	92	101	110	125	134	143	152	-	-	-	-	-	-	-	-	-	-
	Ø 58	133	144	155	165	185	196	207	218	229	240	252	263	274	285	-	-	-	-
	Ø 80	121	133	146	158	179	192	205	218	231	244	257	271	284	297	310	323	336	349
<b>1,20</b>	Ø 25	88	97	-	-	-	-	-	-	-	-	-	-	-	-	-	-	-	-
	Ø 43	89	98	108	118	134	144	154	164	-	-	-	-	-	-	-	-	-	-
	Ø 58	138	150	161	173	194	206	218	230	243	255	267	279	291	303	-	-	-	-
	Ø 80	125	139	152	166	188	202	216	230	245	259	273	287	301	315	329	343	358	372
<b>1,40</b>	Ø 25	93	103	-	-	-	-	-	-	-	-	-	-	-	-	-	-	-	-
	Ø 43	94	104	115	126	143	154	166	177	-	-	-	-	-	-	-	-	-	-
	Ø 58	143	156	168	181	203	216	230	243	256	269	282	296	309	322	-	-	-	-
	Ø 80	130	145	159	174	197	212	228	243	258	273	288	303	319	334	349	364	379	394
<b>1,60</b>	Ø 25	98	108	-	-	-	-	-	-	-	-	-	-	-	-	-	-	-	-
	Ø 43	98	110	122	133	152	165	177	189	-	-	-	-	-	-	-	-	-	-
	Ø 58	148	162	175	189	212	227	241	255	269	283	298	312	326	340	-	-	-	-
	Ø 80	135	151	166	181	207	223	239	255	271	287	304	320	336	352	368	385	401	417
<b>1,80</b>	Ø 25	108	120	-	-	-	-	-	-	-	-	-	-	-	-	-	-	-	-
	Ø 43	108	122	135	148	162	175	188	201	-	-	-	-	-	-	-	-	-	-
	Ø 58	161	176	191	206	222	237	252	267	283	298	313	328	344	359	-	-	-	-
	Ø 80	147	164	181	199	216	233	250	267	285	302	319	336	353	371	388	405	422	439
<b>2,00</b>	Ø 25	113	126	-	-	-	-	-	-	-	-	-	-	-	-	-	-	-	-
	Ø 43	114	128	142	157	171	185	199	214	-	-	-	-	-	-	-	-	-	-
	Ø 58	166	182	198	215	231	247	263	280	296	312	329	345	361	377	-	-	-	-
	Ø 80	152	170	189	207	225	243	261	280	298	316	334	353	371	389	407	426	444	462
<b>2,20</b>	Ø 43	119	134	149	165	180	195	211	226	-	-	-	-	-	-	-	-	-	-
	Ø 58	171	188	205	223	240	257	275	292	309	327	344	361	379	396	-	-	-	-
	Ø 80	157	176	196	215	234	253	273	292	311	331	350	369	388	408	427	446	465	485
<b>2,40</b>	Ø 43	124	140	157	173	189	206	222	238	-	-	-	-	-	-	-	-	-	-
	Ø 58	176	194	213	231	249	268	286	304	323	341	359	378	396	414	-	-	-	-
	Ø 80	162	183	203	223	243	264	284	304	325	345	365	385	406	426	446	467	487	507
<b>2,60</b>	Ø 43	129	146	164	181	199	216	233	251	-	-	-	-	-	-	-	-	-	-
	Ø 58	181	200	220	239	259	278	297	317	336	355	375	394	413	433	-	-	-	-
	Ø 80	167	189	210	231	253	274	295	317	338	359	381	402	423	445	466	487	508	530
<b>2,80</b>	Ø 43	134	153	171	189	208	226	245	263	-	-	-	-	-	-	-	-	-	-
	Ø 58	186	207	227	247	268	288	309	329	349	370	390	410	431	451	-	-	-	-
	Ø 80	173	195	217	240	262	284	307	329	351	374	396	418	441	463	485	508	530	552
<b>3,00</b>	Ø 43	139	159	178	198	217	236	256	275	-	-	-	-	-	-	-	-	-	-
	Ø 58	191	213	234	256	277	298	320	341	363	384	405	427	448	470	-	-	-	-
	Ø 80	178	201	224	248	271	295	318	341	365	388	411	435	458	481	505	528	552	575
<b>3,20</b>	Ø 58	197	219	241	264	286	309	331	354	376	398	421	443	466	488	-	-	-	-
	Ø 80	183	207	232	256	280	305	329	354	378	402	427	451	476	500	524	549	573	597
<b>3,40</b>	Ø 58	202	225	249	272	295	319	342	366	389	413	436	460	483	507	-	-	-	-
	Ø 80	188	213	239	264	290	315	340	366	391	417	442	468	493	518	544	569	595	620
<b>3,60</b>	Ø 58	207	231	256	280	305	329	354	378	403	427	452	476	501	525	-	-	-	-
	Ø 80	193	220	246	272	299	325	352	378	405	431	458	484	510	537	563	590	616	643
<b>3,80</b>	Ø 58	212	237	263	288	314	339	365	391	416	442	467	493	518	544	-	-	-	-
	Ø 80	198	226	253	281	308	336	363	391	418	445	473	500	528	555	583	610	638	665
<b>4,00</b>	Ø 58	217	244	270	297	323	350	376	403	429	456	482	509	536	562	-	-	-	-
	Ø 80	203	232	260	289	317	346	374	403	431	460	488	517	545	574	602	631	659	688



**TARIFA CE-04**

**AMARANT, METAL-LINE, SATINÉ 5500, SPS-6053, CETUS SILVER, SUNSED**

\*Sólo tejidos apropiados y para altos superiores al ancho del tejido llevarán soldadura.

ANCHO ALTO	EJE	1,00	1,20	1,40	1,60	1,80	2,00	2,20	2,40	2,60	2,80	3,00	3,20*	3,40*	3,60*	3,80*	4,00*	4,20*	4,40*
1,00	ø 25	97	107	-	-	-	-	-	-	-	-	-	-	-	-	-	-	-	-
	ø 43	98	110	121	132	153	165	177	189	-	-	-	-	-	-	-	-	-	-
	ø 58	152	165	179	192	221	235	249	263	278	292	306	320	335	349	-	-	-	-
	ø 80	139	154	169	184	214	231	247	264	280	297	313	330	346	363	379	395	412	428
1,20	ø 25	104	115	-	-	-	-	-	-	-	-	-	-	-	-	-	-	-	-
	ø 43	105	117	130	142	166	180	193	206	-	-	-	-	-	-	-	-	-	-
	ø 58	159	173	188	203	233	249	265	280	296	312	327	343	359	374	-	-	-	-
	ø 80	145	162	178	195	227	245	263	281	299	317	335	352	370	388	406	424	442	460
1,40	ø 25	110	123	-	-	-	-	-	-	-	-	-	-	-	-	-	-	-	-
	ø 43	112	125	139	153	179	194	209	223	-	-	-	-	-	-	-	-	-	-
	ø 58	165	181	197	213	246	263	280	297	315	332	349	366	383	400	-	-	-	-
	ø 80	152	170	188	206	240	259	279	298	317	337	356	375	394	414	433	452	472	491
1,60	ø 25	117	131	-	-	-	-	-	-	-	-	-	-	-	-	-	-	-	-
	ø 43	118	133	148	164	192	208	224	241	-	-	-	-	-	-	-	-	-	-
	ø 58	172	189	207	224	259	278	296	315	333	352	370	389	407	426	-	-	-	-
	ø 80	158	178	197	216	253	274	294	315	336	356	377	398	419	439	460	481	502	522
1,80	ø 25	133	150	-	-	-	-	-	-	-	-	-	-	-	-	-	-	-	-
	ø 43	134	152	169	187	205	222	240	258	-	-	-	-	-	-	-	-	-	-
	ø 58	192	212	232	252	272	292	312	332	352	372	391	411	431	451	-	-	-	-
	ø 80	177	199	221	243	266	288	310	332	354	376	399	421	443	465	487	509	532	554
2,00	ø 25	140	158	-	-	-	-	-	-	-	-	-	-	-	-	-	-	-	-
	ø 43	141	160	179	199	218	237	256	275	-	-	-	-	-	-	-	-	-	-
	ø 58	199	221	242	263	285	306	327	349	370	391	413	434	456	477	-	-	-	-
	ø 80	184	208	231	255	278	302	326	349	373	396	420	444	467	491	514	538	561	585
2,20	ø 43	148	169	189	210	230	251	271	292	-	-	-	-	-	-	-	-	-	-
	ø 58	206	229	252	275	297	320	343	366	389	411	434	457	480	503	-	-	-	-
	ø 80	191	216	241	266	291	316	341	366	391	416	441	466	491	516	541	566	591	616
2,40	ø 43	156	177	199	221	243	265	287	309	-	-	-	-	-	-	-	-	-	-
	ø 58	213	238	262	286	310	334	359	383	407	431	456	480	504	528	-	-	-	-
	ø 80	198	225	251	278	304	330	357	383	410	436	463	489	515	542	568	595	621	648
2,60	ø 43	163	186	209	233	256	279	303	326	-	-	-	-	-	-	-	-	-	-
	ø 58	221	246	272	297	323	349	374	400	426	451	477	503	528	554	-	-	-	-
	ø 80	205	233	261	289	317	345	373	400	428	456	484	512	540	568	595	623	651	679
2,80	ø 43	170	195	219	244	269	294	318	343	-	-	-	-	-	-	-	-	-	-
	ø 58	228	255	282	309	336	363	390	417	444	471	498	525	552	579	-	-	-	-
	ø 80	213	242	271	300	330	359	388	418	447	476	505	535	564	593	622	652	681	710
3,00	ø 43	177	203	229	255	282	308	334	360	-	-	-	-	-	-	-	-	-	-
	ø 58	235	263	292	320	349	377	406	434	463	491	520	548	577	605	-	-	-	-
	ø 80	220	250	281	312	342	373	404	435	465	496	527	557	588	619	650	680	711	742
3,20	ø 58	242	272	302	332	362	391	421	451	481	511	541	571	601	631	-	-	-	-
	ø 80	227	259	291	323	355	387	420	452	484	516	548	580	612	644	677	709	741	773
3,40	ø 58	249	280	312	343	374	406	437	468	500	531	562	594	625	656	-	-	-	-
	ø 80	234	267	301	335	368	402	435	469	502	536	569	603	637	670	704	737	771	804
3,60	ø 58	256	289	322	354	387	420	453	485	518	551	584	616	649	682	-	-	-	-
	ø 80	241	276	311	346	381	416	451	486	521	556	591	626	661	696	731	766	801	836
3,80	ø 58	263	297	332	366	400	434	468	503	537	571	605	639	673	708	-	-	-	-
	ø 80	248	285	321	357	394	430	467	503	539	576	612	649	685	721	758	794	830	867
4,00	ø 58	270	306	342	377	413	448	484	520	555	591	626	662	698	733	-	-	-	-
	ø 80	255	293	331	369	407	444	482	520	558	596	633	671	709	747	785	823	860	898





**TARIFA CE-05**

**M-SCREEN 8505, KARELLIS, MISSONI, NATURA, BLACK & WHITE**

ANCHO ALTO	EJE	1,00	1,20	1,40	1,60	1,80	2,00	2,20	2,40	2,60	2,80	3,00
<b>1,00</b>	Ø 25	103	114	-	-	-	-	-	-	-	-	-
	Ø 43	105	117	129	141	160	173	185	198	-	-	-
	Ø 58	160	174	189	203	227	242	257	272	313	329	345
	Ø 80	146	163	179	196	221	239	256	273	315	334	353
<b>1,20</b>	Ø 25	111	123	-	-	-	-	-	-	-	-	-
	Ø 43	112	125	139	153	174	188	202	216	-	-	-
	Ø 58	167	183	199	215	241	258	274	291	334	352	370
	Ø 80	153	171	189	207	235	254	273	292	337	357	378
<b>1,40</b>	Ø 25	118	132	-	-	-	-	-	-	-	-	-
	Ø 43	119	134	149	164	188	203	219	235	-	-	-
	Ø 58	175	192	209	227	255	273	291	309	356	376	395
	Ø 80	161	180	200	219	249	269	290	310	359	381	403
<b>1,60</b>	Ø 25	125	141	-	-	-	-	-	-	-	-	-
	Ø 43	127	143	160	176	201	219	236	253	-	-	-
	Ø 58	182	201	220	238	269	289	308	328	378	399	420
	Ø 80	168	189	210	231	263	285	307	329	380	404	428
<b>1,80</b>	Ø 25	139	156	-	-	-	-	-	-	-	-	-
	Ø 43	140	159	178	196	215	234	253	272	-	-	-
	Ø 58	198	219	240	262	283	304	325	346	399	422	445
	Ø 80	183	207	230	253	277	300	324	347	402	428	453
<b>2,00</b>	Ø 25	146	166	-	-	-	-	-	-	-	-	-
	Ø 43	148	168	188	209	229	249	270	290	-	-	-
	Ø 58	206	229	251	274	297	319	342	365	421	446	470
	Ø 80	191	216	241	266	291	316	340	365	424	451	478
<b>2,20</b>	Ø 43	155	177	199	221	243	265	287	308	-	-	-
	Ø 58	213	238	262	286	310	335	359	383	443	469	495
	Ø 80	199	225	251	278	304	331	357	384	446	474	503
<b>2,40</b>	Ø 43	163	186	210	233	257	280	303	327	-	-	-
	Ø 58	221	247	273	298	324	350	376	402	464	492	520
	Ø 80	206	234	262	290	318	346	374	402	467	498	528
<b>2,60</b>	Ø 43	171	196	221	246	270	295	320	345	-	-	-
	Ø 58	229	256	283	311	338	365	393	420	486	516	545
	Ø 80	214	243	273	303	332	362	391	421	489	521	553
<b>2,80</b>	Ø 43	178	205	231	258	284	311	337	364	-	-	-
	Ø 58	237	265	294	323	352	381	410	438	508	539	571
	Ø 80	222	253	284	315	346	377	408	439	511	544	578
<b>3,00</b>	Ø 43	186	214	242	270	298	326	354	382	-	-	-
	Ø 58	244	275	305	335	366	396	426	457	530	563	596
	Ø 80	229	262	295	327	360	392	425	458	532	568	603
<b>3,20</b>	Ø 58	274	308	343	378	413	447	482	517	551	586	621
	Ø 80	257	294	331	368	406	443	480	517	554	591	628
<b>3,40</b>	Ø 58	282	319	355	391	428	464	500	537	573	609	646
	Ø 80	265	304	343	382	421	459	498	537	576	615	653
<b>3,60</b>	Ø 58	290	329	367	405	443	481	519	557	595	633	671
	Ø 80	274	314	355	395	436	476	517	557	598	638	678
<b>3,80</b>	Ø 58	299	339	378	418	458	497	537	577	616	656	696
	Ø 80	282	324	366	409	451	493	535	577	619	661	703
<b>4,00</b>	Ø 58	307	349	390	431	473	514	555	597	638	679	721
	Ø 80	291	334	378	422	466	510	553	597	641	685	729



**TARIFA CE-06**

**P-STITCH, T-STITCH, S-SCREEN\***

ANCHO ALTO	EJE	1,00	1,20	1,40	1,60	1,80	2,00	2,20	2,40	2,60	2,80	3,00	3,10*
<b>1,00</b>	ø 25	123	139	-	-	-	-	-	-	-	-	-	-
	ø 43	126	142	159	176	193	209	226	243	-	-	-	-
	ø 58	181	200	219	239	258	277	297	316	335	354	374	393
	ø 80	169	190	212	233	255	276	298	319	341	362	384	406
<b>1,20</b>	ø 25	134	152	-	-	-	-	-	-	-	-	-	-
	ø 43	137	156	175	194	213	231	250	269	-	-	-	-
	ø 58	192	213	235	256	278	299	321	342	364	386	407	429
	ø 80	180	203	227	251	275	299	322	346	370	394	417	441
<b>1,40</b>	ø 25	146	166	-	-	-	-	-	-	-	-	-	-
	ø 43	148	169	190	211	233	254	275	296	-	-	-	-
	ø 58	203	227	250	274	298	322	345	369	393	417	440	464
	ø 80	191	217	243	269	295	321	347	373	399	425	451	477
<b>1,60</b>	ø 25	157	179	-	-	-	-	-	-	-	-	-	-
	ø 43	159	182	206	229	253	276	299	323	-	-	-	-
	ø 58	214	240	266	292	318	344	370	396	422	448	474	500
	ø 80	202	230	258	287	315	343	371	399	428	456	484	512
<b>1,80</b>	ø 25	168	192	-	-	-	-	-	-	-	-	-	-
	ø 43	170	196	221	247	273	298	324	349	-	-	-	-
	ø 58	225	253	282	310	338	366	394	423	451	479	507	535
	ø 80	213	243	274	304	335	365	396	426	457	487	517	548
<b>2,00</b>	ø 25	179	206	-	-	-	-	-	-	-	-	-	-
	ø 43	181	209	237	265	293	320	348	376	-	-	-	-
	ø 58	236	267	297	328	358	388	419	449	480	510	540	571
	ø 80	224	257	289	322	355	387	420	453	485	518	551	583
<b>2,20</b>	ø 43	192	222	252	283	313	343	373	403	-	-	-	-
	ø 58	247	280	313	345	378	411	443	476	509	541	574	606
	ø 80	235	270	305	340	375	410	445	479	514	549	584	619
<b>2,40</b>	ø 43	203	236	268	300	333	365	397	429	-	-	-	-
	ø 58	259	293	328	363	398	433	468	503	537	572	607	642
	ø 80	246	284	321	358	395	432	469	506	543	580	617	655
<b>2,60</b>	ø 43	215	249	284	318	353	387	422	456	-	-	-	-
	ø 58	270	307	344	381	418	455	492	529	566	603	640	678
	ø 80	258	297	336	376	415	454	494	533	572	612	651	690
<b>2,80</b>	ø 43	226	262	299	336	373	409	446	483	-	-	-	-
	ø 58	281	320	359	399	438	477	517	556	595	635	674	713
	ø 80	269	310	352	393	435	476	518	560	601	643	684	726
<b>3,00</b>	ø 43	237	276	315	354	393	432	471	509	-	-	-	-
	ø 58	292	333	375	417	458	500	541	583	624	666	707	749
	ø 80	280	324	367	411	455	499	542	586	630	674	718	761
<b>3,20</b>	ø 58	303	347	391	434	478	522	566	609	653	697	741	784
	ø 80	291	337	383	429	475	521	567	613	659	705	751	797
<b>3,40</b>	ø 58	314	360	406	452	498	544	590	636	682	728	774	820
	ø 80	302	350	398	447	495	543	591	640	688	736	784	832
<b>3,60</b>	ø 58	325	373	422	470	518	566	614	663	711	759	807	855
	ø 80	313	364	414	464	515	565	616	666	717	767	818	868
<b>3,80</b>	ø 58	336	387	437	488	538	588	639	689	740	790	841	891
	ø 80	324	377	430	482	535	588	640	693	746	798	851	904
<b>4,00</b>	ø 58	348	400	453	505	558	611	663	716	769	821	874	927
	ø 80	335	390	445	500	555	610	665	720	775	829	884	939



## INTRODUCCIÓN

Aplicar un cajón de aluminio a una cortina enrollable, se hace principalmente para proteger el tejido y los sistemas de accionamiento de las inclemencias climáticas.

PERSAX® dispone de una gama de cajones, con colorido y diseño, capaces de armonizar en el entorno donde se instalan. Disponible de manera estándar en color blanco, podemos lacar cualquier color de la carta RAL.

Para su instalación en el exterior, disponemos de varios sistemas de guiado, que permiten sujetar el terminal contrapeso para que no lo mueva el viento.

Instalada en su balcón, pérgola de jardín o porche, con tejido screen o tejido Sunsed, crea un ambiente abierto y confortable.



## DATOS NECESARIOS PARA REALIZAR UN PEDIDO (1)

ARTÍCULO	TEJIDOS TÉCNICOS		TEJIDOS DECORATIVOS	TEJIDOS OPACOS
	Referencia Color		Referencia Color	Referencia Color
MEDIDAS	Ancho X Alto			
LADO MANDO	Izquierda		Derecha	
SISTEMAS DE EJE	ø25	ø43	ø43	ø58
TIPO DE CAJÓN	<b>CAJÓN DE 77</b> 		<b>CAJÓN DE 92</b> 	
<i>Alto máximo según tabla de tejidos página 19</i>				
ACCIONAMIENTO	<p style="text-align: center;"><b>ESTANDAR</b></p>			

**ACCESORIOS DE INSTALACIÓN (Sin cargo. Incluidos en el precio de la cortina)**

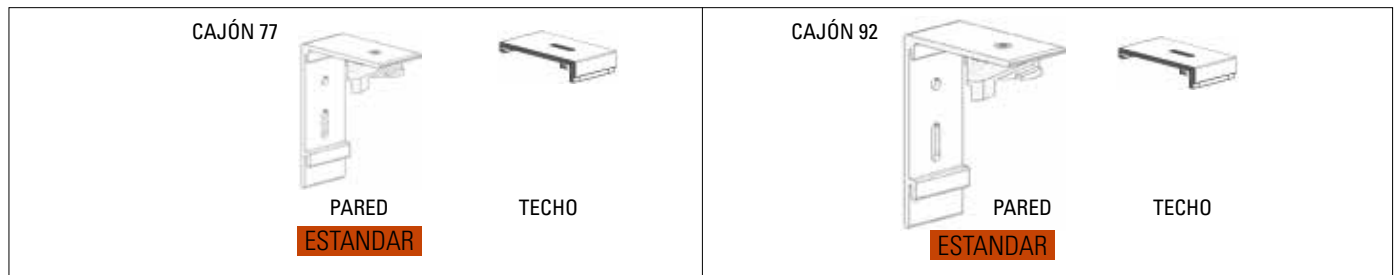
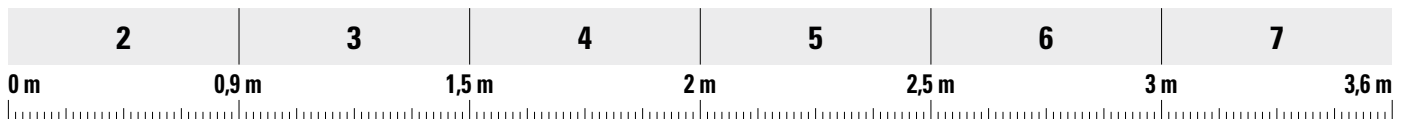

**INCREMENTOS**

ARTÍCULO	CÓDIGO	PRECIO €
SOLDADURAS EN TEJIDOS APROPIADOS	882026	12,50
REFUERZOS LATERALES EN TEJIDOS APROPIADOS	882024	18,00
CADENA METÁLICA	882018	10,50
ACCIONAMIENTO A MUELLE EJE 25	882023	18,75

**INCREMENTO POR GUÍA CERRADA**

REPRESENTACIÓN	CÓDIGO	ARTÍCULO	PRECIO €/ und. - m
	382054	GUÍA CERRADA DE 55 BLANCA	15,95
	382057	GUÍA CERRADA DE 55 CON ALETA BLANCA	17,15
	182070	EMBUDO GUÍA CERRADA 55 BLANCO      NEGRO <b>ESTANDAR</b>	0,65
	182048	JUEGO TAPÓN CON ALETA REMATE ALUMINIO PLANO BLANCO      NEGRO <b>ESTANDAR</b>	1,05

**INCREMENTO POR GUÍA VENTILADA**

REPRESENTACIÓN	CÓDIGO	ARTÍCULO	PRECIO €/ und. - m
	482021	GUÍA VENTILADA BLANCA	6,05
	182189	CASQUILLO REMATE REDONDO 18	0,70
	182188	PISTON GUIA VENTILADA	1,05



## DESCUENTOS DE MEDIDA DEL TEJIDO

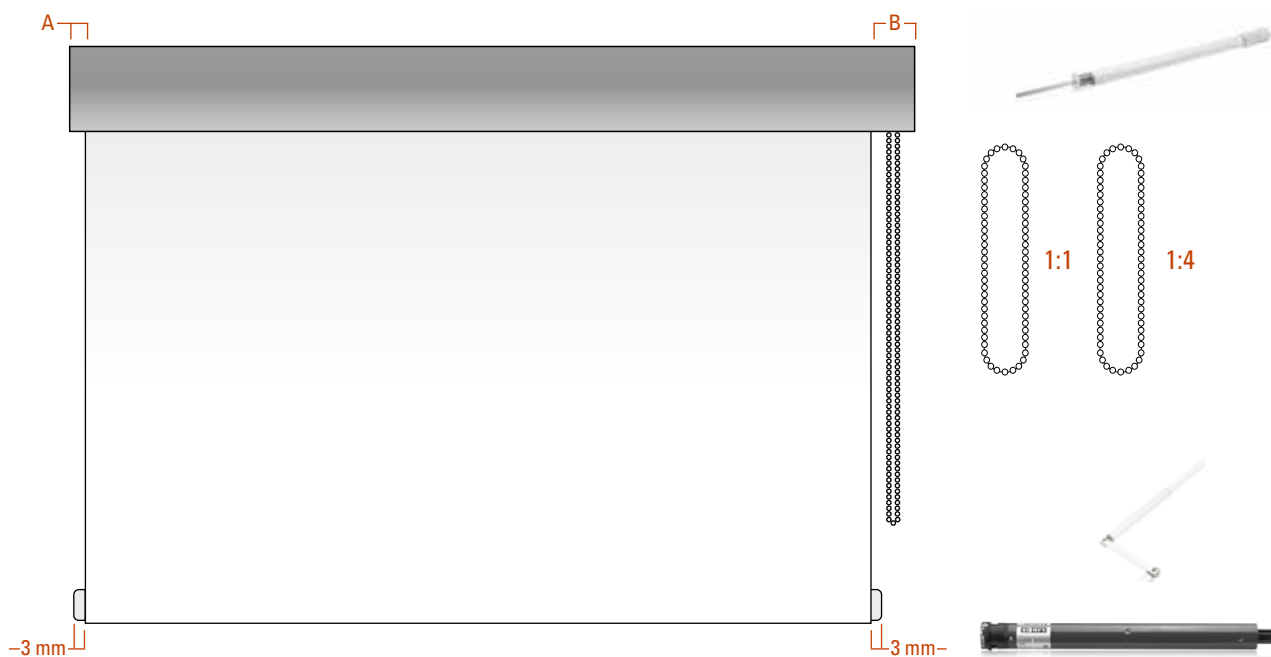

## TABLA DE DESCUENTOS SISTEMA CAJÓN

ACCIONAMIENTO EJE	MUELLE		CADENA 1:1		CADENA 1:4		MANIVELA		MOTOR	
	A	B	A	B	A	B	A	B	A	B
<b>ø25</b>	19 mm	20 mm	19 mm	23 mm	-	-	-	-	-	-
<b>ø43</b>	-	-	22 mm	24 mm	-	-	-	-	22 mm	33 mm
<b>ø58</b>	-	-	-	-	33 mm	34 mm	33 mm	35 mm	33 mm	40 mm

## INCREMENTOS GUIADO A CABLE

CONJUNTO GUIADO A CABLE

COD. 819006
<b>82,50 € / unidad cortina completa</b>

REPRESENTACIÓN	CÓDIGO	ARTÍCULO	PRECIO € / und.
	182056	ESCUADRA CON TENSOR PARED-SUELO GUIADO A CABLE	20,90
	111011	CABLE DE ACERO 2.5 MM (7 metros)	10,75
	182189	CASQUILLO REMATE REDONDO 18	0,70
	182146	PISTÓN GUIADO A CABLE	1,06

**COMPONENTES - CORTINA ENROLLABLE CON CAJÓN**

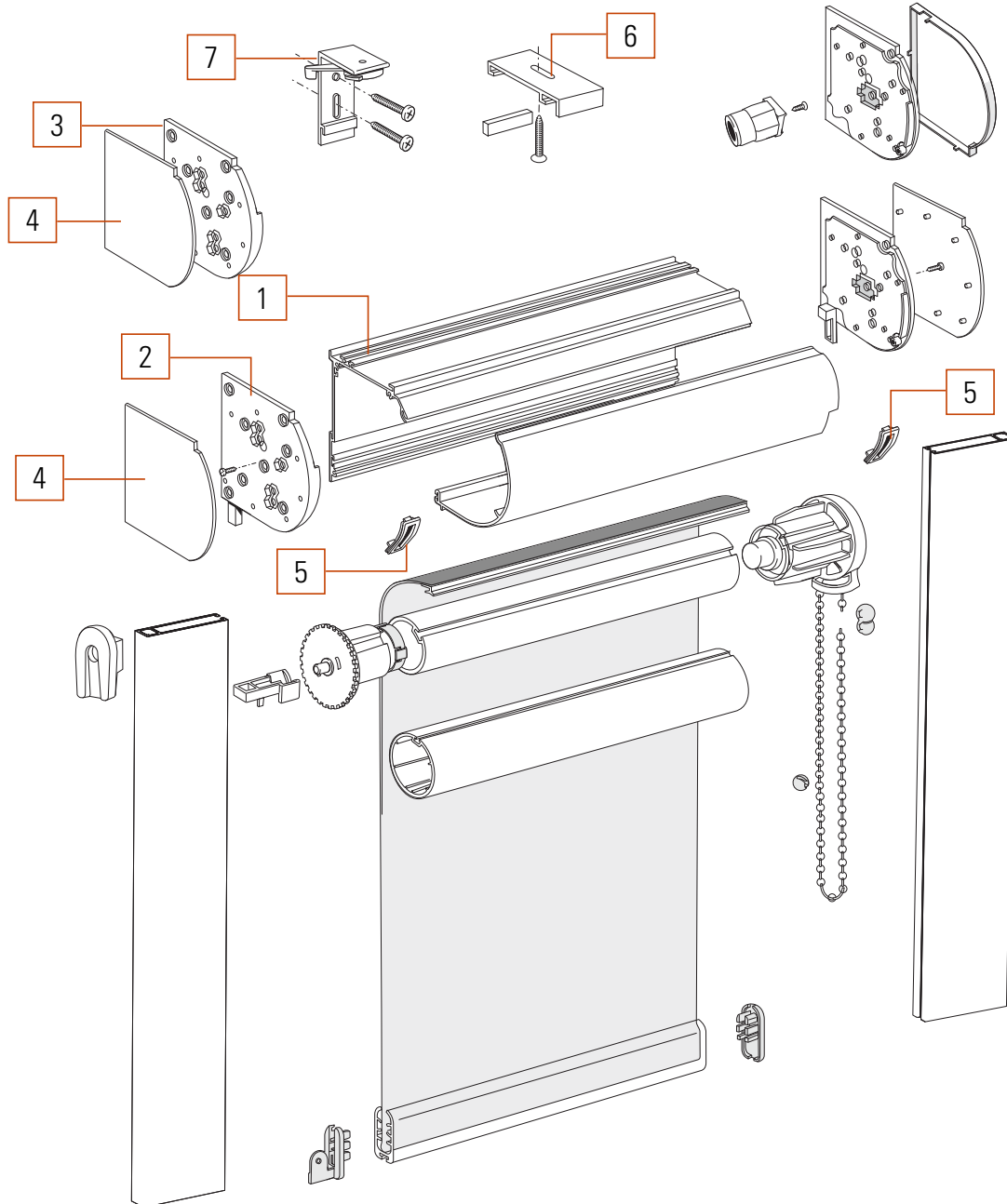

Nº	COMPONENTE	CAJÓN	CODIGO
1	Cajón completo	77	482042
		92	482044
2	Juego tapas laterales con patas	77	182050
		92	182191
3	Juego tapas laterales	77	182099
		92	182190
4	Juego tapas embellecedoras	77	182051
		92	182192

Nº	COMPONENTE	CAJÓN	CODIGO
5	Salida cadena mando cajón izq	77	182076
		92	182194
5	Salida cadena mando cajón der	77	182054
		92	182193
6	Soporte techo cajón	77	182047
		92	182196
7	Soport pared cajón	77	182089
		92	182195





GAMA	COMP.	Kg gr/m <sup>2</sup>	ANCHO	CARACTERÍSTICAS	ALTURA MÁXIMA EN CM			TARIFA				
					Cajón 77-ø43	Cajón 92-ø43	Cajón 92-ø58					
TEJIDOS DECORATIVOS	TENDENCE	100% PES	130	230 cm				400	680	360	2	
	JUNO	100% PES	160	230 cm				280	540	310	2	
	CETUS	Trevira CS	140	230 cm				380	650	350	2	
	JUPITER	Trevira CS	150	250 cm				360	650	350	2	
	POLARIS	Trevira CS	200	230 cm				360	680	360	1	
	MISSONI	100% PES	130	280 cm				340	660	350	5	
	NATURA	Fibra V. / PVC	400	250 cm				260	590	320	5	
	CLASSIC	100% PES	220	300 cm				260	620	340	1	
	RUSTIK	100% PES	180	300 cm				260	620	340	1	
	SHANTUNG FR	100% PES	180	320 cm				260	620	340	1	
TEJIDOS OPACOS	KARELLIS	100% PES	300	300 cm				400	720	450	5	
	JUNO BLACK OUT	100% PES	280	230 cm				260	650	390	3	
	TENDENCE BLACKOUT	100% PES	220	230 cm				320	650	390	3	
	OPAC 487	Fibra V. / PVC	487	300 cm					400	720	450	3
TEJIDOS TÉCNICOS	SATINÉ 5500	Fibra V. / PVC	520	250 cm					190	400	250	4
	SPS-6053	PES / PVC	600	300 cm					190	400	250	4
	SPS-4155	PES / PVC	410	300 cm					240	500	270	2
	M-SCREEN 8505	Fibra V. / PVC	405	250 cm					280	590	320	5
	B-SCREEN 1%	Fibra V. / PVC	410	320 cm					280	590	320	3
	B-SCREEN 3%	Fibra V. / PVC	380	320 cm					280	590	320	3
	B-SCREEN 5%	Fibra V. / PVC	365	320 cm					280	590	320	3
	CETUS SIVER	Trevira CS	140	230 cm					380	650	350	4
	SUNSED	PES / PVC	420	300 cm					200	400	250	4
	POLIVISIÓN	100% PES	195	300 cm					260	620	340	1





**TARIFA CEC-01**

**POLARIS, SHANTUNG FR, CLASSIC, RUSTIK, POLIVISION**

ANCHO ALTO	EJE	CAJÓN	1,00	1,20	1,40	1,60	1,80	2,00	2,20	2,40	2,60	2,80	3,00
<b>1,00</b>	ø 25	77	176	192	-	-	-	-	-	-	-	-	-
	ø 43	77	177	193	208	226	242	258	276	292	-	-	-
		92	183	199	215	236	252	268	288	302	-	-	-
ø 58	92	211	230	250	272	292	311	322	354	376	396	416	
<b>1,20</b>	ø 25	77	179	195	-	-	-	-	-	-	-	-	-
	ø 43	77	180	196	211	230	247	263	282	299	-	-	-
		92	186	202	219	240	257	273	295	309	-	-	-
ø 58	92	214	233	254	277	297	316	328	361	384	404	425	
<b>1,40</b>	ø 25	77	192	210	-	-	-	-	-	-	-	-	-
	ø 43	77	193	211	228	248	267	285	305	323	-	-	-
		92	199	218	236	259	277	295	318	334	-	-	-
ø 58	92	229	250	272	297	319	340	354	389	414	436	458	
<b>1,60</b>	ø 25	77	195	214	-	-	-	-	-	-	-	-	-
	ø 43	77	196	215	232	253	272	291	312	330	-	-	-
		92	202	221	240	264	282	301	325	341	-	-	-
ø 58	92	232	254	277	302	325	346	360	396	421	444	467	
<b>1,80</b>	ø 25	77	198	217	-	-	-	-	-	-	-	-	-
	ø 43	77	199	218	236	258	277	297	318	338	-	-	-
		92	205	225	244	268	288	307	331	348	-	-	-
ø 58	92	235	257	281	307	330	352	367	403	429	453	476	
<b>2,00</b>	ø 25	77	201	221	-	-	-	-	-	-	-	-	-
	ø 43	77	202	222	240	263	283	303	325	345	-	-	-
		92	208	228	248	273	293	313	338	355	-	-	-
ø 58	92	238	261	285	312	336	358	373	410	437	461	485	
<b>2,20</b>	ø 25	77	204	225	-	-	-	-	-	-	-	-	-
	ø 43	77	205	225	245	268	288	309	332	352	-	-	-
		92	211	232	252	278	298	319	344	362	-	-	-
ø 58	92	241	265	289	316	341	364	380	417	445	469	494	
<b>2,40</b>	ø 43	77	208	229	249	272	294	315	338	359	-	-	-
		92	214	235	257	283	304	325	351	370	-	-	-
	ø 58	92	244	268	293	321	346	370	387	425	452	478	503
<b>2,60</b>	ø 43	77	211	233	253	277	299	321	345	366	-	-	-
		92	217	239	261	288	309	331	358	377	-	-	-
	ø 58	92	247	272	298	326	352	376	393	432	460	486	512
<b>2,80</b>	ø 43	77	214	236	257	282	304	327	351	374	-	-	-
		92	220	243	265	292	315	337	364	384	-	-	-
	ø 58	92	250	275	302	331	357	382	400	439	468	494	521
<b>3,00</b>	ø 43	77	217	240	261	287	310	333	358	381	-	-	-
		92	223	246	269	297	320	343	371	391	-	-	-
	ø 58	92	253	279	306	336	363	388	406	446	476	503	530
<b>3,20</b>	ø 58	92	256	283	310	340	368	394	413	453	484	511	539
<b>3,40</b>	ø 58	92	259	286	314	345	373	400	420	461	491	520	548



**TARIFA CEC-02**

**CETUS, JUPITER, TENDENCE, JUNO, SCREEN SPS-4155**

ANCHO ALTO	EJE	CAJÓN	1,00	1,20	1,40	1,60	1,80	2,00	2,20	2,40	2,60	2,80	3,00
<b>1,00</b>	ø 25	77	178	194	-	-	-	-	-	-	-	-	-
		92	179	195	210	229	245	261	280	296	-	-	-
	ø 43	77	185	201	217	238	255	271	292	306	-	-	-
		92	213	232	252	275	295	314	326	358	381	401	422
<b>1,20</b>	ø 25	77	181	198	-	-	-	-	-	-	-	-	-
		92	182	199	214	234	250	267	287	304	-	-	-
	ø 43	77	188	205	222	243	260	277	299	313	-	-	-
		92	216	236	257	280	301	320	333	366	389	410	431
<b>1,40</b>	ø 25	77	195	213	-	-	-	-	-	-	-	-	-
		92	195	214	231	252	271	289	310	329	-	-	-
	ø 43	77	202	220	239	263	281	300	323	339	-	-	-
		92	232	253	276	301	324	345	359	395	420	443	465
<b>1,60</b>	ø 25	77	198	217	-	-	-	-	-	-	-	-	-
		92	199	218	236	258	277	296	318	337	-	-	-
	ø 43	77	205	224	243	268	287	306	331	347	-	-	-
		92	235	257	281	306	330	352	366	403	429	452	475
<b>1,80</b>	ø 25	77	201	221	-	-	-	-	-	-	-	-	-
		92	202	222	240	263	283	302	325	345	-	-	-
	ø 43	77	208	228	248	273	293	313	338	355	-	-	-
		92	238	261	285	312	336	359	374	410	437	461	485
<b>2,00</b>	ø 25	77	204	225	-	-	-	-	-	-	-	-	-
		92	205	226	245	268	289	309	332	353	-	-	-
	ø 43	77	212	232	253	278	299	319	345	363	-	-	-
		92	242	265	290	317	342	365	381	418	446	470	495
<b>2,20</b>	ø 25	77	208	229	-	-	-	-	-	-	-	-	-
		92	209	230	250	273	294	316	339	360	-	-	-
	ø 43	77	215	236	257	284	305	326	352	371	-	-	-
		92	245	269	294	322	348	372	388	426	454	479	505
<b>2,40</b>	ø 43	77	212	234	254	279	300	322	347	368	-	-	-
		92	218	240	262	289	311	332	359	379	-	-	-
	ø 58	92	248	273	299	328	354	378	395	434	463	489	515
<b>2,60</b>	ø 43	77	215	238	259	284	306	329	354	376	-	-	-
		92	222	244	266	294	317	339	367	387	-	-	-
	ø 58	92	251	277	304	333	359	385	402	442	471	498	525
<b>2,80</b>	ø 43	77	218	241	263	289	312	335	361	384	-	-	-
		92	225	248	271	299	322	346	374	394	-	-	-
	ø 58	92	255	281	308	338	365	391	410	450	480	507	534
<b>3,00</b>	ø 43	77	222	245	268	294	318	342	368	392	-	-	-
		92	228	252	276	305	328	352	381	402	-	-	-
	ø 58	92	258	285	313	343	371	398	417	458	488	516	544
<b>3,20</b>	ø 58	92	261	289	317	349	377	404	424	466	497	525	554
<b>3,40</b>	ø 58	92	265	293	322	354	383	411	431	473	505	535	564



**TARIFA CEC-03**

**JUNO BLACKOUT, TENDENCE BLACKOUT, OPAC 487, B-SCREEN 1% - 3% - 5%**

ANCHO ALTO	EJE	CAJÓN	1,00	1,20	1,40	1,60	1,80	2,00	2,20	2,40	2,60	2,80	3,00
<b>1,00</b>	ø 25	77	188	206	-	-	-	-	-	-	-	-	-
		77	189	207	224	245	264	282	303	321	-	-	-
	ø 43	92	195	213	232	255	273	292	315	331	-	-	-
		92	224	245	268	293	315	337	351	385	410	433	455
<b>1,20</b>	ø 25	77	192	212	-	-	-	-	-	-	-	-	-
		77	194	213	231	253	272	291	313	332	-	-	-
	ø 43	92	200	219	238	263	282	301	325	342	-	-	-
		92	229	251	275	300	324	346	361	397	422	446	469
<b>1,40</b>	ø 25	77	209	230	-	-	-	-	-	-	-	-	-
		77	210	231	251	275	297	318	342	364	-	-	-
	ø 43	92	216	238	259	286	307	328	355	374	-	-	-
		92	247	272	297	326	352	376	393	431	460	486	511
<b>1,60</b>	ø 25	77	214	236	-	-	-	-	-	-	-	-	-
		77	215	237	258	283	306	328	353	376	-	-	-
	ø 43	92	221	244	266	294	316	339	366	386	-	-	-
		92	252	278	304	334	361	386	404	443	473	500	526
<b>1,80</b>	ø 25	77	219	242	-	-	-	-	-	-	-	-	-
		77	220	243	265	291	315	338	364	388	-	-	-
	ø 43	92	226	250	273	302	325	349	377	398	-	-	-
		92	257	284	311	342	370	396	415	456	486	514	541
<b>2,00</b>	ø 25	77	224	248	-	-	-	-	-	-	-	-	-
		77	225	249	272	299	324	348	375	400	-	-	-
	ø 43	92	231	256	280	310	334	359	388	410	-	-	-
		92	262	290	318	350	379	406	426	468	499	528	557
<b>2,20</b>	ø 25	77	229	254	-	-	-	-	-	-	-	-	-
		77	230	255	279	307	333	358	386	412	-	-	-
	ø 43	92	236	262	287	318	343	369	399	422	-	-	-
		92	267	296	325	358	388	416	437	480	512	542	572
<b>2,40</b>	ø 43	77	235	261	286	316	342	368	397	424	-	-	-
		92	241	268	294	326	352	379	410	434	-	-	-
	ø 58	92	272	302	333	366	397	426	448	492	525	556	587
<b>2,60</b>	ø 43	77	240	267	294	324	351	378	408	436	-	-	-
		92	246	274	301	334	361	389	421	446	-	-	-
	ø 58	92	277	308	340	374	406	436	459	504	538	570	602
<b>2,80</b>	ø 43	77	245	273	301	332	360	388	419	448	-	-	-
		92	251	280	308	342	370	399	432	458	-	-	-
	ø 58	92	282	314	347	382	415	446	470	516	551	584	617
<b>3,00</b>	ø 43	77	250	279	308	340	369	398	431	460	-	-	-
		92	256	286	315	350	379	409	443	470	-	-	-
	ø 58	92	287	320	354	390	424	456	481	528	564	598	632
<b>3,20</b>	ø 58	92	292	326	361	398	433	466	492	540	577	612	647
<b>3,40</b>	ø 58	92	297	332	368	406	442	476	503	552	590	626	662



**TARIFA CEC-04**

**AMARANT, METAL LINE, SATINÉ 5500, SPS-6053, CETUS SILVER, SUNSED**

ANCHO ALTO	EJE	CAJÓN	1,00	1,20	1,40	1,60	1,80	2,00	2,20	2,40	2,60	2,80	3,00
<b>1,00</b>	ø 25	77	192	210	-	-	-	-	-	-	-	-	-
		92	193	212	230	252	271	290	312	331	-	-	-
	ø 43	77	199	218	237	261	281	300	324	340	-	-	-
		92	229	251	274	300	323	345	360	396	421	445	468
<b>1,20</b>	ø 25	77	197	217	-	-	-	-	-	-	-	-	-
		92	198	219	238	260	280	301	323	344	-	-	-
	ø 43	77	204	225	245	270	290	310	336	353	-	-	-
		92	234	257	282	308	333	356	372	409	435	460	484
<b>1,40</b>	ø 25	77	214	236	-	-	-	-	-	-	-	-	-
		92	215	238	259	284	307	329	354	377	-	-	-
	ø 43	77	222	244	267	295	317	340	367	387	-	-	-
		92	253	279	306	335	362	388	406	446	475	502	529
<b>1,60</b>	ø 25	77	220	243	-	-	-	-	-	-	-	-	-
		92	221	245	267	293	317	341	367	391	-	-	-
	ø 43	77	228	251	275	304	327	351	380	401	-	-	-
		92	259	286	314	344	372	399	418	459	490	518	546
<b>1,80</b>	ø 25	77	225	250	-	-	-	-	-	-	-	-	-
		92	227	252	275	303	327	352	380	404	-	-	-
	ø 43	77	233	258	283	313	338	362	392	415	-	-	-
		92	264	292	322	353	383	411	431	473	505	534	563
<b>2,00</b>	ø 25	77	231	257	-	-	-	-	-	-	-	-	-
		92	232	258	283	312	338	364	392	418	-	-	-
	ø 43	77	239	265	291	322	348	374	405	428	-	-	-
		92	270	299	330	363	393	422	443	487	520	550	580
<b>2,20</b>	ø 25	77	237	264	-	-	-	-	-	-	-	-	-
		92	238	265	291	321	348	375	405	432	-	-	-
	ø 43	77	245	272	299	331	358	385	417	442	-	-	-
		92	276	306	338	372	403	433	456	500	534	566	597
<b>2,40</b>	ø 43	77	244	272	299	330	358	386	417	445	-	-	-
		92	250	279	307	340	368	397	430	456	-	-	-
	ø 58	92	281	313	346	381	413	445	468	514	549	582	615
<b>2,60</b>	ø 43	77	250	279	307	339	368	398	430	459	-	-	-
		92	256	285	315	349	379	408	443	469	-	-	-
	ø 58	92	287	320	354	390	424	456	481	528	564	598	632
<b>2,80</b>	ø 43	77	255	286	315	348	379	409	442	473	-	-	-
		92	262	292	323	358	389	419	455	483	-	-	-
	ø 58	92	293	327	361	399	434	468	494	541	579	614	649
<b>3,00</b>	ø 43	77	261	293	323	357	389	420	455	486	-	-	-
		92	267	299	331	367	399	431	468	497	-	-	-
	ø 58	92	299	333	369	408	444	479	506	555	594	630	666
<b>3,20</b>	ø 58	92	304	340	377	417	454	490	519	569	608	646	683
<b>3,40</b>	ø 58	92	310	347	385	426	465	502	531	582	623	662	700



TARIFA CEC-05

MISSONI, NATURA, KARELLIS, M-SCREEN 8505

ANCHO ALTO	EJE	CAJÓN	1,00	1,20	1,40	1,60	1,80	2,00	2,20	2,40	2,60	2,80	3,00
<b>1,00</b>	ø 25	77	212	233	-	-	-	-	-	-	-	-	-
		92	220	242	263	290	312	333	360	379	-	-	-
	ø 43	77	214	235	255	279	301	322	347	368	-	-	-
		92	253	277	304	332	359	383	400	440	468	494	521
<b>1,20</b>	ø 25	77	218	241	-	-	-	-	-	-	-	-	-
		92	227	249	272	300	323	346	374	394	-	-	-
	ø 43	77	220	243	264	290	312	335	361	383	-	-	-
		92	259	285	312	343	370	396	414	455	485	512	540
<b>1,40</b>	ø 25	77	237	261	-	-	-	-	-	-	-	-	-
		92	245	270	296	327	352	377	408	431	-	-	-
	ø 43	77	238	263	287	316	341	366	394	420	-	-	-
		92	279	308	338	371	401	430	451	495	528	558	588
<b>1,60</b>	ø 25	77	243	270	-	-	-	-	-	-	-	-	-
		92	252	279	305	337	364	391	423	447	-	-	-
	ø 43	77	245	272	297	326	353	379	409	436	-	-	-
		92	286	316	348	382	413	444	465	511	545	577	608
<b>1,80</b>	ø 25	77	250	278	-	-	-	-	-	-	-	-	-
		92	259	287	314	348	376	404	438	463	-	-	-
	ø 43	77	252	280	306	337	365	393	424	452	-	-	-
		92	293	324	357	393	425	457	480	527	562	595	628
<b>2,00</b>	ø 25	77	257	286	-	-	-	-	-	-	-	-	-
		92	265	295	324	359	388	417	452	479	-	-	-
	ø 43	77	258	288	315	348	377	406	438	468	-	-	-
		92	299	332	366	403	437	470	495	543	580	614	648
<b>2,20</b>	ø 25	77	290	323	-	-	-	-	-	-	-	-	-
		92	299	333	367	406	440	474	514	544	-	-	-
	ø 43	77	291	325	357	394	428	462	498	532	-	-	-
		92	337	374	413	455	494	532	560	615	657	696	735
<b>2,40</b>	ø 43	77	299	334	368	406	441	476	514	550	-	-	-
		92	306	342	377	418	453	489	530	562	-	-	-
	ø 58	92	344	383	424	467	508	547	576	632	676	717	757
<b>2,60</b>	ø 43	77	306	343	378	418	454	491	531	567	-	-	-
		92	314	350	387	430	467	503	546	580	-	-	-
	ø 58	92	351	392	434	479	521	561	593	650	695	737	779
<b>2,80</b>	ø 43	77	313	352	388	429	467	506	547	585	-	-	-
		92	321	359	397	442	480	518	562	597	-	-	-
	ø 58	92	359	401	444	491	534	576	609	668	714	758	801
<b>3,00</b>	ø 43	77	321	360	398	441	481	520	563	603	-	-	-
		92	328	368	408	453	493	533	578	615	-	-	-
	ø 58	92	366	409	454	502	547	591	625	685	733	778	823
<b>3,20</b>	ø 58	92	373	418	465	514	561	605	641	703	752	799	845
<b>3,40</b>	ø 58	92	381	427	475	526	574	620	657	721	771	819	867



## INTRODUCCIÓN

La cortina MINIBOX es un producto ideal, que se adapta a la mayoría de ventanas. Instalada sobre los junquillos del cristal, ocupan muy poco espacio, permitiendo abrir y cerrar la ventana prácticamente sin restricciones. Solo es necesario disponer de un junquillo, con mínimo de 12 mm de fondo para su instalación.

Disponemos de una gran variedad de tejidos y colorido, que permiten graduar la intensidad de luz que queremos dejar entrar, hasta el punto de obtener casi total opacidad.

Podemos lacar en cualquier color de la carta RAL, para conseguir que la MINIBOX se adapte a su entorno.



## MÉTODO DE MEDICIÓN

### ANCHURA

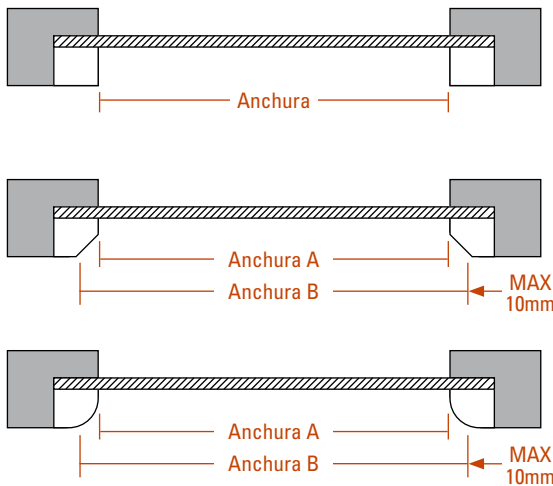

En el caso de junquillo recto se deberá proporcionar la Anchura de LUZ.

En el caso de los junquillos "achaflanado" o "curvo", se proporcionará la medida Anchura A (luz) y la Anchura B.

Hay que tener en cuenta que la diferencia entre las medidas A y B no podrá ser superior a 20 mm (10 mm por cada lado)

### ALTURA

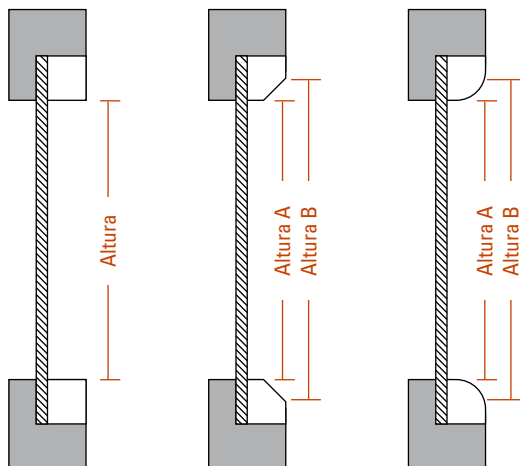

En el caso de junquillo recto se deberá proporcionar la Altura de LUZ.





En el caso de los junquillos "achaflanado" o "curvo", se proporcionará la medida Altura A (luz) y la Altura B.



En TODOS los casos, la profundidad del junquillo debe medir un mínimo de 12 mm

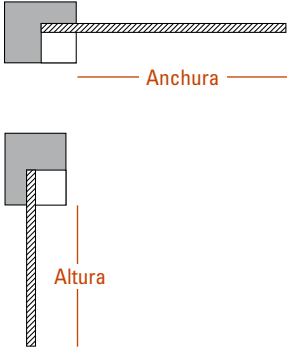
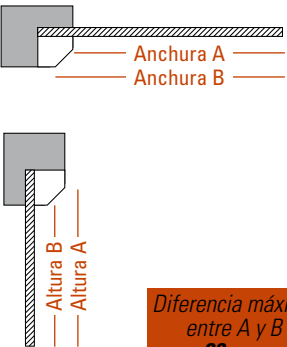
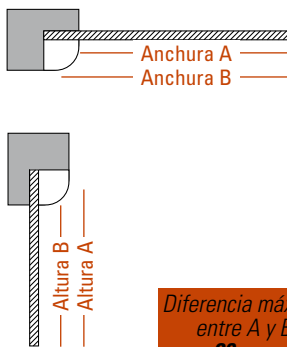

























**DATOS NECESARIOS PARA REALIZAR UN PEDIDO**

TEJIDO	TEJIDOS TÉCNICOS	TEJIDOS DECORATIVOS	TEJIDOS OPACOS
	Referencia Color	Referencia Color	Referencia Color
MEDIDAS	Con Junquillo Recto	Con Junquillo Achaflanado	Con Junquillo Curvo
			
		<b>Diferencia máxima entre A y B 20 mm</b>	<b>Diferencia máxima entre A y B 20 mm</b>
En todos los casos el grueso del junquillo debe medir mínimo 12 mm			
LADO MANDO	Izquierda		Derecha
COLORES	PERFILES		ACCESORIOS
	 Blanco <b>ESTANDAR</b>	 Otros Colores RAL ↑	 Blanco <b>ESTANDAR</b>

**MEDIDAS MÁXIMAS Y MÍNIMAS A FABRICAR**

ANCHO MÍNIMO	ANCHO MÁXIMO	ALTO MÍNIMO	ALTO MÁXIMO	OCUPACIÓN CABEZAL
25 cm	120 cm	-	Límites según tejidos	8 cm

**TEJIDOS CORTINA ENROLLABLE CON CAJÓN**

GAMA	COMP.	kg gr/m <sup>2</sup>	ANCHO	CARACTERÍSTICAS	ALTURA MAX		
					Cajón mini	TARIFA CORTINA COMPLETA	
TEJIDOS DECORATIVOS	TENDENCE	100% PES	130	230 cm		<b>220 cm</b>	<b>2</b>
	CETUS	Trevira CS	140	230 cm	 	<b>220 cm</b>	<b>2</b>
	JUPITER	Trevira CS	150	250 cm		<b>220 cm</b>	<b>2</b>
	POLARIS	Trevira CS	200	230 cm	 	<b>220 cm</b>	<b>1</b>
TEJIDOS OPACOS	KARELLIS	100% PES	300	300 cm	 	<b>200 cm</b>	<b>4</b>
	TENDENCE BLACKOUT	100% PES	220	230 cm		<b>220 cm</b>	<b>3</b>
	OPAC 487	Fibra V. / PVC	487	300 cm	  	<b>120 cm</b>	<b>3</b>
TEJIDOS SCREEN	M-SCREEN 8505	Fibra V. / PVC	405	250 cm	 	<b>140 cm</b>	<b>4</b>
	B-SCREEN 1%	Fibra V. / PVC	410	320 cm	  	<b>140 cm</b>	<b>3</b>
	B-SCREEN 3%	Fibra V. / PVC	380	320 cm	  	<b>150 cm</b>	<b>3</b>
	B-SCREEN 5%	Fibra V. / PVC	365	320 cm	  	<b>150 cm</b>	<b>3</b>
	CETUS SIVER	Trevira CS	140	230 cm	 	<b>220 cm</b>	<b>4</b>
	POLIVISIÓN	100% PES	195	300 cm		<b>140 cm</b>	<b>1</b>





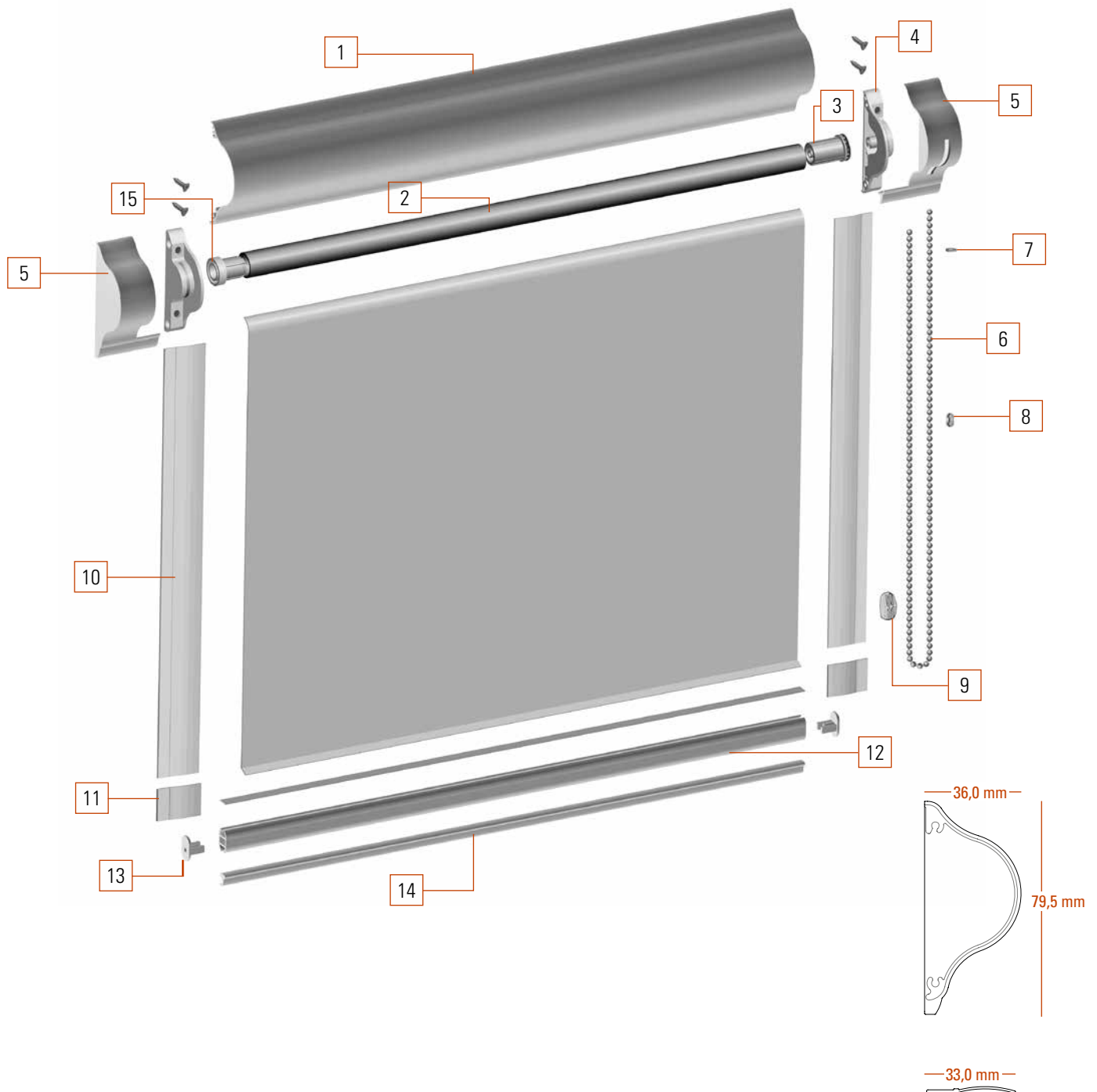

Nº	COMPONENTE	CÓDIGO
1	Cajón 36 Minibox	382078
2	Eje de 18 Minibox	382085
3	Mecanismo cadena 18 Minibox	182103
4	Conjunto Sop. Mec. Cadena 18 Minibox	182082
5	Juego tapas cajón Minibox izq	182100
5	Juego tapas cajón Minibox der	182101
6	Cadena Minibox PVC 3.2 x 6 mm	382083
7	Tope cadena Minibox	182107

Nº	COMPONENTE	CÓDIGO
8	Unión cadena Minibox	182108
9	Soporte cadena Minibox	182102
10	Guía Al Adhesiva Minibox	382079
11	Juego tapones guía Minibox	182106
12	Remate Minibox	382081
13	Tapón remate Minibox	182105
14	Goma remate Minibox	382082
15	Contera de 18 Minibox	182104

**TARIFA MBOX-01 POLARIS, POLIVISION**

ALTO \ ANCHO	0,40	0,60	0,80	1,00	1,20
<b>1,00</b>	111	121	129	138	147
<b>1,20</b>	115	124	134	143	152
<b>1,40</b>	117	128	138	148	158
<b>1,60</b>	121	131	142	152	162
<b>1,80</b>	123	135	146	156	168
<b>2,00</b>	127	138	149	162	173
<b>2,20</b>	129	141	154	166	179

\*Ver altos máximos según tejidos en la página 31.

**TARIFA MBOX-02 TENDENCE, CETUS, JUPITER**

ALTO \ ANCHO	0,40	0,60	0,80	1,00	1,20
<b>1,00</b>	112	122	131	139	149
<b>1,20</b>	116	125	136	145	154
<b>1,40</b>	118	129	139	151	160
<b>1,60</b>	122	132	144	155	165
<b>1,80</b>	124	137	148	159	172
<b>2,00</b>	128	140	152	165	177
<b>2,20</b>	131	143	157	169	183

\*Ver altos máximos según tejidos en la página 31.

**TARIFA MBOX-03 OPAC 487, B-SCREEN 1%-3%-5%**

ALTO \ ANCHO	0,40	0,60	0,80	1,00	1,20
<b>1,00</b>	116	128	138	149	161
<b>1,20</b>	120	132	145	156	168
<b>1,40</b>	123	137	150	163	176
<b>1,60</b>	128	141	156	169	183
<b>1,80</b>	131	146	161	175	191
<b>2,00</b>	135	151	166	183	198
<b>2,20</b>	138	155	172	189	206

\*Ver altos máximos según tejidos en la página 31.

**TARIFA MBOX-04 KARELLIS, M-SCREEN 8505, CETUS SILVER**

ALTO \ ANCHO	0,40	0,60	0,80	1,00	1,20
<b>1,00</b>	118	130	142	154	166
<b>1,20</b>	122	135	149	162	174
<b>1,40</b>	126	141	155	170	183
<b>1,60</b>	130	145	162	176	191
<b>1,80</b>	134	151	167	183	201
<b>2,00</b>	139	156	173	191	209
<b>2,20</b>	142	160	180	198	218

\*Ver altos máximos según tejidos en la página 31.



## INTRODUCCIÓN

PERSAX® presenta su nuevo Screen Zip, un novedoso sistema de estor enrollable con cofre. El sistema incorpora una cremallera soldada en los laterales del tejido que aporta una mayor resistencia al viento que los sistemas convencionales, y, en el caso de utilizar un tejido opaco, conseguir una total ausencia de luz en el interior de la casa.

Protección solar y Ahorro Energético: Reduce el calor interior en su hogar y evita reflejos de luz molestos.

Intimidad y Oscurecimiento total en el interior de su vivienda.



## DATOS NECESARIOS PARA REALIZAR UN PEDIDO

TEJIDO	TEJIDOS TÉCNICOS (ver colección)	TEJIDOS OPACOS (ver colección)
	Referencia Color	Referencia Color
MEDIDAS	Ancho	Alto
LADO MOTOR	Izquierda	Derecha
COLOR	Blanco <b>ESTANDAR</b>	Lacados Carta RAL <b>↑</b>

## MEDIDAS MÁXIMAS Y MÍNIMAS A FABRICAR

CAJÓN	ANCHO MÍNIMO	ANCHO MÁXIMO	ALTO MÍNIMO	ALTO MÁXIMO	OCUPACIÓN CAJÓN
100	60 cm	400 cm	100 cm	320 cm	10 cm
130	60 cm	500 cm	100 cm	500 cm	13 cm

## TEJIDOS COMPATIBLES

										CORTINA COMPLETA
GAMA		COMP.	gr/m²	ANCHO	CARACTERÍSTICAS					TARIFA
TÉCNICOS	SATINÉ 5500	Fibra. V / PVC	520	320 cm 250 cm						<b>1</b>
	SUNSED	PES / PVC	420	300 cm						<b>1</b>
OPACOS	OPAC 487	Fibra. V / Vinilo	487	300 cm						<b>1</b>



**COMPONENTES - SCREEN ZIP**

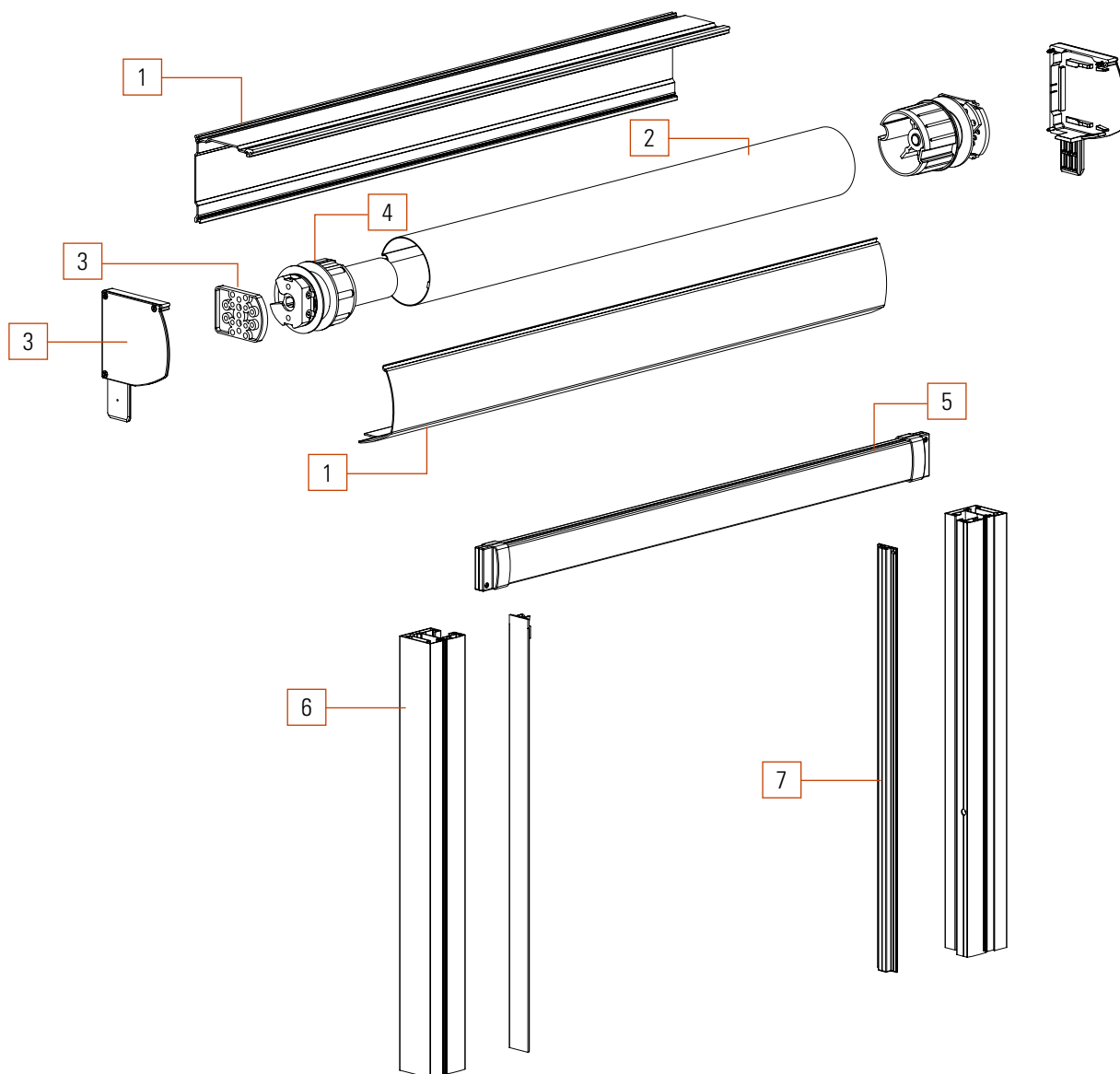

Nº	COMPONENTE	CÓDIGO
1	Perfiles Cofre	-
2	Eje de 70 ojiva	380018
3	Kit Screen ZIP 100	182095
	Kit Screen ZIP 130	182140
4	Motor	-
5	Barra de carga 100	382072
	Barra de carga 130	382106
6	Guía Posterior 100	382071
	Guía Posterior 1300	382105
7	Perfil Cierre Lona	382075

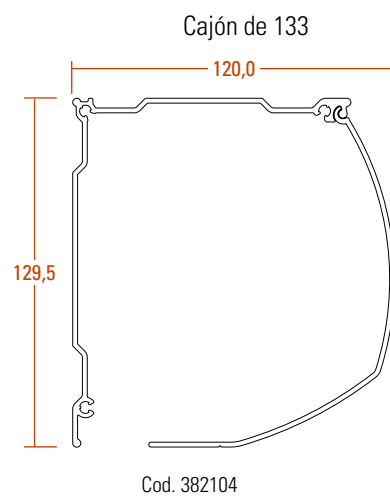
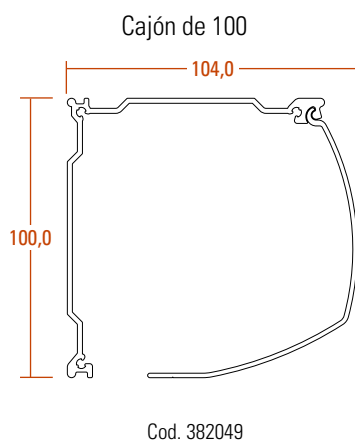

## TARIFA SCREEN ZIP-01

ANCHO ALTO	CAJÓN	1,00	1,20	1,40	1,60	1,80	2,00	2,20	2,40	2,60	2,80	3,00	3,20	3,40	3,60	3,80	4,00	4,20	4,40	4,60	4,80	5,00
1,00	100	310	331	352	373	394	415	436	457	478	499	520	541	562	583	604	625	-	-	-	-	-
	130	326	354	381	409	436	464	491	518	546	573	601	628	656	683	711	738	766	793	820	848	875
1,20	100	341	363	385	407	430	452	474	496	519	541	563	585	608	630	652	674	-	-	-	-	-
	130	356	385	414	442	471	500	528	557	586	614	643	672	701	729	758	787	815	844	873	901	930
1,40	100	371	395	418	442	465	489	512	536	559	583	606	630	653	677	700	723	-	-	-	-	-
	130	386	416	446	476	506	536	566	596	626	656	685	715	745	775	805	835	865	895	925	955	985
1,60	100	402	426	451	476	501	525	550	575	599	624	649	674	698	723	748	773	-	-	-	-	-
	130	416	447	479	510	541	572	603	634	665	697	728	759	790	821	852	884	915	946	977	1008	1039
1,80	100	432	458	484	510	536	562	588	614	640	666	692	718	744	770	796	822	-	-	-	-	-
	130	446	479	511	543	576	608	641	673	705	738	770	803	835	867	900	932	965	997	1029	1062	1094
2,00	100	463	490	517	544	571	599	626	653	680	707	735	762	789	816	843	871	-	-	-	-	-
	130	476	510	543	577	611	644	678	712	745	779	812	846	880	913	947	981	1014	1048	1082	1115	1149
2,20	100	493	521	550	578	607	635	664	692	720	749	777	806	834	863	891	920	-	-	-	-	-
	130	506	541	576	611	646	680	715	750	785	820	855	890	925	959	994	1029	1064	1099	1134	1169	1204
2,40	100	523	553	583	612	642	672	701	731	761	790	820	850	880	909	939	969	-	-	-	-	-
	130	536	572	608	644	680	717	753	789	825	861	897	933	969	1006	1042	1078	1114	1150	1186	1222	1258
2,60	100	554	585	616	647	677	708	739	770	801	832	863	894	925	956	987	1018	-	-	-	-	-
	130	566	603	641	678	715	753	790	827	865	902	940	977	1014	1052	1089	1126	1164	1201	1238	1276	1313
2,80	100	584	616	649	681	713	745	777	809	841	874	906	<b>938</b>	<b>970</b>	<b>1002</b>	<b>1034</b>	<b>1067</b>	-	-	-	-	-
	130	596	635	673	712	750	789	827	866	905	943	982	<b>1020</b>	<b>1059</b>	<b>1098</b>	<b>1136</b>	<b>1175</b>	<b>1213</b>	<b>1252</b>	<b>1291</b>	<b>1329</b>	<b>1368</b>
3,00	100	615	648	681	715	748	782	815	848	882	915	949	<b>982</b>	<b>1015</b>	<b>1049</b>	<b>1082</b>	<b>1116</b>	-	-	-	-	-
	130	626	666	706	745	785	825	865	905	945	984	1024	<b>1064</b>	<b>1104</b>	<b>1144</b>	<b>1183</b>	<b>1223</b>	<b>1263</b>	<b>1303</b>	<b>1343</b>	<b>1383</b>	<b>1422</b>
3,20	100	645	680	714	749	784	818	853	888	922	957	991	<b>1026</b>	<b>1061</b>	<b>1095</b>	<b>1130</b>	<b>1165</b>	-	-	-	-	-
	130	656	697	738	779	820	861	902	943	984	1025	1067	<b>1108</b>	<b>1149</b>	<b>1190</b>	<b>1231</b>	<b>1272</b>	<b>1313</b>	<b>1354</b>	<b>1395</b>	<b>1436</b>	<b>1477</b>
3,40	130	686	728	770	813	855	897	940	982	1024	1067	1109	<b>1151</b>	<b>1193</b>	<b>1236</b>	<b>1278</b>	<b>1320</b>	<b>1363</b>	<b>1405</b>	<b>1447</b>	<b>1490</b>	<b>1532</b>
3,60	130	716	759	803	846	890	933	977	1021	1064	1108	1151	<b>1195</b>	<b>1238</b>	<b>1282</b>	<b>1325</b>	<b>1369</b>	<b>1412</b>	<b>1456</b>	<b>1500</b>	<b>1543</b>	<b>1587</b>
3,80	130	746	790	835	880	925	970	1014	1059	1104	1149	1194	<b>1238</b>	<b>1283</b>	<b>1328</b>	<b>1373</b>	<b>1417</b>	<b>1462</b>	<b>1507</b>	<b>1552</b>	<b>1597</b>	<b>1641</b>
4,00	130	776	822	868	914	960	1006	1052	1098	1144	1190	1236	<b>1282</b>	<b>1328</b>	<b>1374</b>	<b>1420</b>	<b>1466</b>	<b>1512</b>	<b>1558</b>	<b>1604</b>	<b>1650</b>	<b>1696</b>
4,20	130	806	853	900	947	995	1042	1089	1136	1184	1231	1278	<b>1325</b>	<b>1373</b>	<b>1420</b>	<b>1467</b>	<b>1514</b>	<b>1562</b>	<b>1609</b>	<b>1656</b>	<b>1704</b>	<b>1751</b>
4,40	130	836	884	933	981	1030	1078	1127	1175	1224	1272	1321	<b>1369</b>	<b>1418</b>	<b>1466</b>	<b>1515</b>	<b>1563</b>	<b>1611</b>	<b>1660</b>	<b>1708</b>	<b>1757</b>	<b>1805</b>
4,60	130	866	915	965	1015	1064	1114	1164	1214	1263	1313	1363	<b>1413</b>	<b>1462</b>	<b>1512</b>	<b>1562</b>	<b>1612</b>	<b>1661</b>	<b>1711</b>	<b>1761</b>	<b>1810</b>	<b>1860</b>
4,80	130	895	946	997	1048	1099	1150	1201	1252	1303	1354	1405	<b>1456</b>	<b>1507</b>	<b>1558</b>	<b>1609</b>	<b>1660</b>	<b>1711</b>	<b>1762</b>	<b>1813</b>	<b>1864</b>	<b>1915</b>
5,00	130	925	978	1030	1082	1134	1186	1239	1291	1343	1395	1448	<b>1500</b>	<b>1552</b>	<b>1604</b>	<b>1656</b>	<b>1709</b>	<b>1761</b>	<b>1813</b>	<b>1865</b>	<b>1917</b>	<b>1970</b>

Motor 6 Nm / 32 r.p.m

Motor 10 Nm / 17 r.p.m

Motor 15 Nm / 17 r.p.m

Las zonas en **NEGRITA** representan las medidas en las que el tejido llevará soldaduras horizontales.

Precios cotizados en BLANCO. Para 1013, 3005, 6005, 6009, 7011, 7022, 8014, 8017, INOX, PLATA BRONCE y NEGRO un incremento del 15%. Otros colores: consultar precio.

Los precios NO INCLUYEN EL MOTOR Y EMISOR



**INCREMENTOS MOTORES PARA ZIP**  (con sistema de detección de obstáculos)

	MOTOR	CÓDIGO	PAR NOMINAL	VELOCIDAD	TENSIÓN	POTENCIA	DECIBELIOS	PRECIO €
	MAESTRIA iO 50 6/32	1241066	6 Nm	32 r.p.m	230 V AC	120 W	52 dBA	305,15
	MAESTRIA iO 50 10/17	1241067	10 Nm	17 r.p.m		120 W	54 dBA	310,85
	MAESTRIA iO 50 15/17	1241068	15 Nm			140 W	54 dBA	320,85

**ACCESORIOS PARA MOTORIZACIÓN**

	REPRESENTACIÓN	CÓDIGO	DESCRIPCIÓN	PRECIO € / und.
		124811	EMISOR Situo iO 1 CANAL	86,20
		135022	EMISOR Situo iO 4 CANAL	132,55
		124093	CENTRALITA TAHOMA	590,00

Disponemos de toda la gama SOMFY, consulte precios



## INTRODUCCIÓN

La cortina vertical PERSAX<sup>®</sup> es una solución perfecta para cubrir grandes espacios.

Fabricada con lamas verticales en anchos de 89, 127 y 250 mm y la posibilidad de replegar las lamas a la derecha, izquierda, ambos lados ó al centro, es el producto para la decoración más versátil.

Disponibile en lama de aluminio de 89 mm así como en una gran variedad de tejidos y acabados, ofrece una solución para cada estilo de decoración.

Con la posibilidad de fabricarla en plano inclinado, en curvas y diferentes cortes de lama, es aplicable en sitios que otros productos no llegan.



## SISTEMAS Y VERSIONES

VERSIONES	LAMA
Aluminio	Lama 89 mm
Tejidos Decorativos	Lama 89 mm
Tejidos Opacos	Lama 127 mm
Tejidos Técnicos	Lama 250 mm

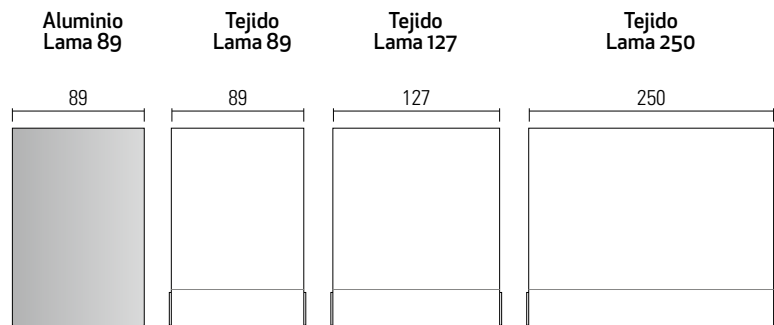

## MEDIDAS MÁXIMAS Y MÍNIMAS A FABRICAR

LAMA	ANCHO MÍNIMO	ANCHO MÁXIMO	ALTO MÍNIMO	ALTO MÁXIMO
<b>Aluminio 89 mm</b>	1 lama	Ver tabla de precios	15 cm	Ver tablas de precios
<b>Tejido 89 mm</b>	1 lama		15 cm	
<b>Tejido 127 mm</b>				
<b>Tejido 250 mm</b>				

## OCUPACIÓN DE REPLIEGUES

89 mm		127 mm		250 mm	
<i>Fórmula para calcular ocupación de lamas conociendo el ancho de la cortina</i>					
Repliegue a un lado	Repliegue ambos lados	Repliegue a un lado	Repliegue ambos lados	Repliegue a un lado	Repliegue ambos lados
0,15 x medida de cabezal en cm.		0,105 x medida de cabezal en cm.		0,01 x medida de cabezal en cm.	
+8	+16	+10	+20	+19,1	+38,2
<i>Fórmula para calcular el ancho de la cortina conociendo el hueco que pretendemos dejar libre</i>					
Medida de hueco en cm.		Medida de hueco en cm.		Medida de hueco en cm.	
+8 : 0,85	+16 : 0,85	+10 : 0,895	+20 : 0,895	+19,1 : 1,09	+38,2 : 1,09



**DATOS NECESARIOS PARA REALIZAR UN PEDIDO**

<b>ARTÍCULO / COLOR</b>	Aluminio <sup>(2)</sup>	Color	Lama 89 Mm	Tejido	Color	Lama 89 mm	
						Lama 127 mm	
						Lama 250 mm <sup>(1)</sup>	
<b>MEDIDAS</b>	Ancho X Alto						
<b>ACCIONAMIENTO</b>	Cordón / Cadena		Motor ↑		Entre cristales mando radio ↑		
<b>MANDOS</b>			<b>REPLIEGUES</b>				
Izquierda		Derecha		Derecha	Izquierda	Ambos Lados	Centro
<b>ESCUADRAS</b>	Ver incrementos en página 64						
<b>ALTO MANDOS</b>	ALTO CORTINA			LARGO MANDOS			
	Hasta 1,50 m			5 cm menos del alto de la cortina			
	De 1,50 a 2,80 m			1,50 m			
	Más de 2,80 m			1 m menos del alto de la cortina			

<sup>(1)</sup> La cortina vertical con lamas de tejido de 250 mm de ancho lleva pletina contrapeso en lugar de placa y no lleva cadena de conexión.

<sup>(2)</sup> La cortina vertical con lama de aluminio NO lleva cadena conexión

**ACCESORIOS DE INSTALACIÓN (Sin cargo. Incluidos en el precio de la cortina)**

2	3	4	5	6	
0 m	1,20 m	2,40 m	3,60 m	4,80 m	6 m
<b>ESTANDAR</b>		<b>EXCLUSIVO PARA VERTICAL INCLINADA</b>			

**PRECIOS CABEZALES**

	89 mm	127 mm	250 mm
CABEZAL COMPLETO - Colores: <b>Blanco</b> <b>Plata</b> <b>Marrón</b> <b>ESTANDAR</b>	63,80 € / m	61,20 € / m	57,60 € / m
	Cod. 218027	Cod. 218028	Cod. 218036

Indicar SIEMPRE si es para Tejido o Aluminio

Mínimo a facturar 1 metro lineal.



	GAMA	COLORES	MATERIAL	CARACTERÍSTICAS			CORTINA COMPLETA	LAMAS CONFECCIONADAS - €/m		
							TARIFA	89 mm	127 mm	250 mm
<b>ALUMINIO</b>	LISO	2	Aluminio				<b>1</b>	4.72	-	-
	PERFORADO	2	Aluminio				<b>1</b>	6.56	-	-
<b>TEJIDOS DECORATIVOS</b>	TENDENCE	10	100% PES				<b>3</b>	1.68	2.48	7.50
	JUNO	15	100% PES				<b>3</b>	1.64	2.48	7.40
	CETUS	14	Trevira CS				<b>3</b>	1.68	2.48	7.50
	CHEVRON	5	100% PES				<b>4</b>	2.28	3.38	9.55
	JÚPITER	8	Trevira CS				<b>3</b>	1.84	2.88	8.00
	POLARIS	40	Trevira CS				<b>2</b>	1.60	2.43	7.50
	SHANTUNG FR	9	100% PES				<b>2</b>	0.94	1.58	6.70
<b>TEJIDOS OPACOS</b>	JUNO BLACKOUT	6	100% PES				<b>4</b>	3.40	5.22	9.45
	OPAC 487	8	Fibra V. / PVC				<b>4</b>	2.36	3.87	10.90
<b>TEJIDOS TÉCNICOS</b>	CETUS SILVER	3	Trevira CS				<b>5</b>	2.48	3.83	10.40
	SPS-4155	8	PES / PVC				<b>3</b>	2.76	4.23	7.25
	SUNSED	20	PES / PVC				<b>5</b>	3.80	6.03	12.00
	B-SCREEN 1%	8	Fibra V. / PVC				<b>4</b>	3.40	5.22	12.30
	B-SCREEN 3%	8	Fibra V. / PVC				<b>4</b>	3.32	5.13	9.20
	B-SCREEN 5%	8	Fibra V. / PVC				<b>4</b>	3.20	4.95	8.80
	M-SCREEN 8505	18	Fibra V. / PVC				<b>5</b>	3.28	5.27	12.30
	NATURA	5	Fibra V. / PVC				<b>5</b>	4.28	6.66	12.55

Mínimo a facturar 1 metro lineal.

## SEGURIDAD INFANTIL

SEGURIDAD INFANTIL	CÓDIGO	DESCRIPCIÓN	PRECIO €/ und.
	119055	SOPORTE RECOGEDOR CORDÓN	3,10
	119059	TENSOR CORDÓN / CADENA	3,40

## INCREMENTOS

DESCRIPCIÓN	CÓDIGO	INCREMENTO €/UND CORTINA COMPLETA
LAMAS COMBINADAS (COLORES DISTINTOS DENTRO DE UNA MISMA CORTINA) <sup>(1)</sup>	818001	23,00
VERSIÓN ALUMINIO (CADENA CONEXIÓN)	818002	14,10

(1) En el caso de incluir tejidos de varias gamas, se facturará siempre la gama más alta.

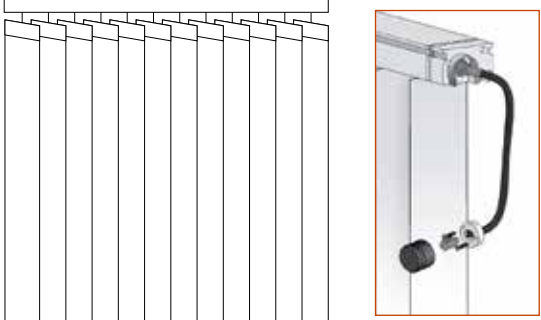
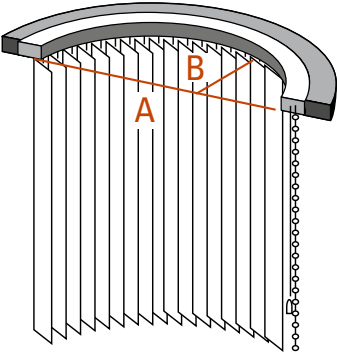

**INCREMENTOS**

ENTRECRISTALES MANDO RADIO	RIEL CURVO GALERÍA EN "U"
 <p style="text-align: center; background-color: #8B4513; color: white; padding: 2px;">Sólo gradúa</p>	 <p style="text-align: center; background-color: #8B4513; color: white; padding: 2px;">Ciertas curvas no se pueden fabricar. Por favor, consúltenos su caso primero.</p> <p style="text-align: center;">NECESARIAS MEDIDAS A y B O PLANTILLA NO APTA PARA MOTORIZACIÓN</p>
Cod. 819001 - 19,15 €/unidad cortina completa	Cod. 818004 - 234,00 €/unidad cortina completa

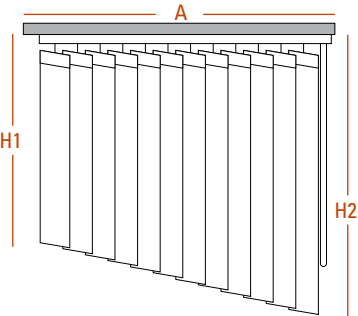
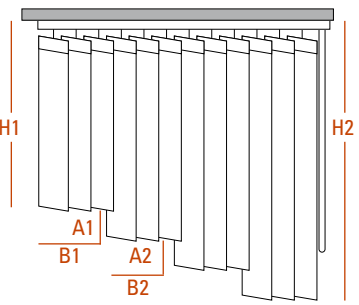
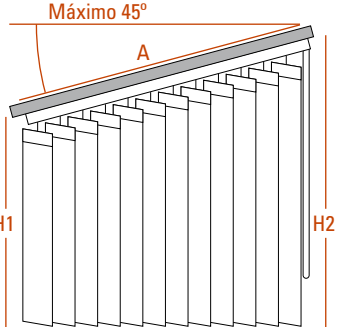
INCLINADO CABEZAL HORIZONTAL	INCLINADO LAMAS EN ESCALERA	INCLINADO CABEZAL INCLINADO
		 <p style="text-align: center;">Máximo 45°</p> <p style="text-align: center;">NO APTA PARA MOTORIZACIÓN</p>
Cod. 818005 - 22,15 €/und. cortina completa	Cod. 818007 - 60,00 €/und. cortina completa	Cod. 818006 - 31,60 €/und. cortina completa

**MOTORIZACIÓN**

	CÓDIGO	DESCRIPCIÓN	PRECIO €/UNIDAD
 <p>REPLIEGUE SOLO DERECHA O IZQUIERDA</p>		PULSADOR	
	818003	SISTEMA MOTOR	498,96
	1241055	PULSADOR	75,80
	1241056	EMISOR 1 CANAL MOT VERTICAL	62,55
	1241057	EMISOR 5 CANALES MOT VERTICAL	109,40
	1241058	EMISOR 24 CANALES MOT VERTICAL	242,10



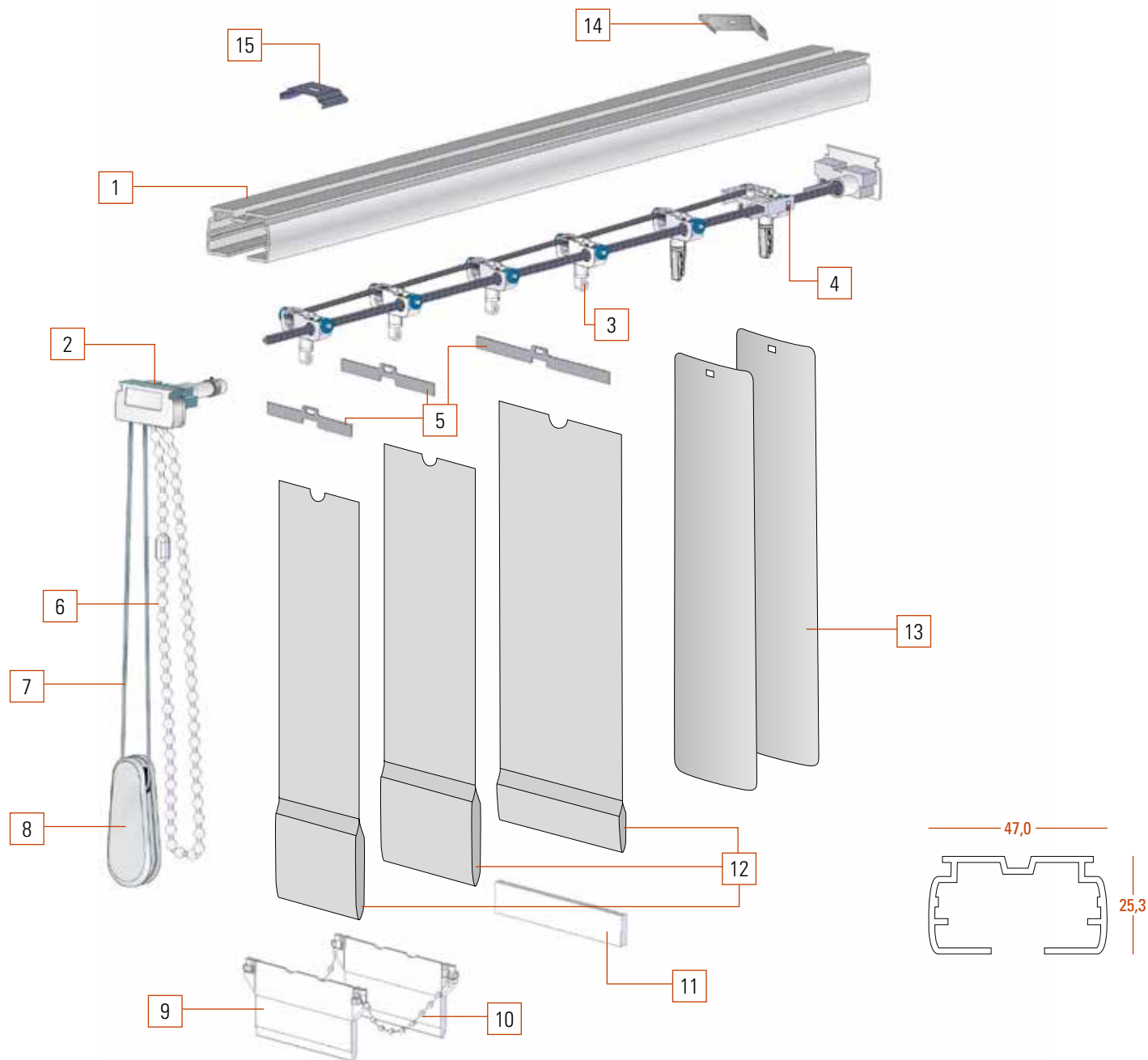

Nº	COMPONENTE	LAMA	CÓDIGO
1	Riel cortina vertical		318027
2	Control mecanismo izq.		118041
2	Control mecanismo der.		118027
3	Transportador gancho		118028
4	Carro de arrastre c. vertical		118030
5	Soporte telas	89	118011
		127	118013
		250	118043
6	Cadena mando PVC		318042
7	Cordón de 2,0 mm		318041
8	Pomo perita		118034

Nº	COMPONENTE	LAMA	CÓDIGO
9	Contrapeso	89	118010
		127	118012
10	Cadena distanciadora	89	318025
		127	318026
11	Pletina aluminioi 4 mm	250	337003
		89	218029
		127	218030
12	Lama tejido	127	218030
		250	218037
		89	218038
13	Lama aluminio liso	89	218038
	Lama aluminio perf.	89	218039
14	Clip vertical inclinada		118042
15	Clip instalación techo		182087

**TARIFA CV-01 - ALUMINIO 89 MM**

ALTO \ ANCHO	LAMA	1,00	1,20	1,40	1,60	1,80	2,00	2,20	2,40
<b>1,00</b>	Liso	105	121	128	144	155	171	180	191
	Perforado	124	143	154	174	188	208	220	235
<b>1,20</b>	Liso	111	127	137	154	166	183	192	206
	Perforado	133	154	166	187	206	226	239	257
<b>1,40</b>	Liso	118	134	145	162	177	196	206	220
	Perforado	143	165	180	203	223	246	260	279
<b>1,60</b>	Liso	124	143	154	174	188	208	218	234
	Perforado	153	176	192	217	239	263	279	302
<b>1,80</b>	Liso	130	150	161	182	199	220	231	249
	Perforado	161	187	204	231	255	282	299	324
<b>2,00</b>	Liso	135	158	171	192	210	233	246	263
	Perforado	171	199	217	247	272	302	319	343
<b>2,20</b>	Liso	143	165	178	202	222	244	258	278
	Perforado	180	210	230	261	288	319	338	366
<b>2,40</b>	Liso	149	174	187	212	233	256	272	292
	Perforado	190	223	242	276	305	337	358	388
<b>2,60</b>	Liso	155	180	197	222	242	268	284	306
	Perforado	199	233	256	289	321	357	379	410
<b>2,80</b>	Liso	161	187	204	231	255	281	298	320
	Perforado	208	244	267	305	338	375	398	432
<b>3,00</b>	Liso	169	196	213	240	265	293	310	335
	Perforado	218	256	281	319	354	393	417	454

ALTO \ ANCHO	LAMA	2,60	2,80	3,00	3,20	3,40	3,60	3,80	4,00
<b>1,00</b>	Liso	207	218	234	242	255	263	282	295
	Perforado	255	270	289	302	318	331	353	368
<b>1,20</b>	Liso	223	235	252	261	274	284	304	319
	Perforado	279	295	318	331	347	363	386	405
<b>1,40</b>	Liso	238	252	270	281	294	306	327	342
	Perforado	303	321	345	359	379	395	421	441
<b>1,60</b>	Liso	254	268	288	300	315	329	351	367
	Perforado	326	347	372	388	410	430	457	475
<b>1,80</b>	Liso	268	286	306	319	335	350	372	390
	Perforado	351	373	401	417	441	462	491	512
<b>2,00</b>	Liso	284	303	325	337	356	370	395	414
	Perforado	373	399	428	446	471	494	526	548
<b>2,20</b>	Liso	300	319	342	357	377	393	417	438
	Perforado	396	423	455	474	502	527	561	585
<b>2,40</b>	Liso	315	336	361	377	396	414	441	462
	Perforado	420	449	484	505	533	560	594	620
<b>2,60</b>	Liso	332	353	379	394	416	436	464	485
	Perforado	444	475	511	533	564	592	629	656
<b>2,80</b>	Liso	347	369	396	414	437	458	486	510
	Perforado	468	501	538	561	594	625	665	692
<b>3,00</b>	Liso	363	388	415	433	458	479	510	533
	Perforado	491	527	566	591	625	657	699	727



TARIFA CV-02

SHANTUNG FR, POLARIS

ALTO \ ANCHO	LAMA	1,00	1,20	1,40	1,60	1,80	2,00	2,20	2,40	2,60	2,80	3,00	3,20	3,40
<b>1,00</b>	89	96	116	136	153	173	193	212	229	249	269	289	308	326
	127	86	104	122	139	157	175	190	208	225	243	261	279	293
	250	90	108	126	143	155	173	191	209	227	245	262	280	298
<b>1,20</b>	89	100	120	141	158	179	199	220	238	258	279	299	320	337
	127	89	108	126	144	163	181	196	215	233	252	270	289	304
	250	94	113	132	151	162	181	200	219	238	257	275	294	313
<b>1,40</b>	89	103	124	146	164	185	206	228	246	267	288	309	331	349
	127	92	111	130	149	169	188	203	222	241	260	280	299	314
	250	99	119	138	158	170	190	209	229	249	269	288	308	328
<b>1,60</b>	89	107	129	151	169	191	213	235	254	276	298	320	342	360
	127	95	115	135	154	174	194	210	229	249	269	289	309	324
	250	103	124	145	166	177	198	219	239	260	281	301	322	343
<b>1,80</b>	89	110	133	156	175	197	220	243	262	285	307	330	353	372
	127	98	118	139	159	180	200	216	237	257	278	298	319	335
	250	108	130	151	173	185	206	228	249	271	293	314	336	357
<b>2,00</b>	89	114	137	161	180	204	227	250	270	294	317	340	364	383
	127	101	122	143	164	185	207	223	244	265	286	307	329	345
	250	113	135	158	180	192	215	237	259	282	305	327	350	372
<b>2,20</b>	89	117	141	166	186	210	234	258	278	302	327	351	375	395
	127	104	126	148	169	191	213	230	251	273	295	317	339	355
	250	117	141	164	188	199	223	246	270	293	317	340	363	387
<b>2,40</b>	89	120	145	170	191	216	241	266	286	311	336	361	386	407
	127	107	129	152	174	197	219	236	259	281	304	326	348	366
	250	122	146	171	195	207	231	255	280	304	329	353	377	402
<b>2,60</b>	89	124	150	175	196	222	248	273	294	320	346	371	397	418
	127	110	133	156	179	202	226	243	266	289	312	335	358	376
	250	127	152	177	202	214	239	265	290	315	341	366	391	416
<b>2,80</b>	89	127	154	180	202	228	255	281	302	329	355	382	408	430
	127	113	137	161	184	208	232	250	273	297	321	345	368	386
	250	131	157	184	210	222	248	274	300	326	353	379	405	431
<b>3,00</b>	89	131	158	185	207	234	261	289	311	338	365	392	419	441
	127	116	140	165	189	214	238	256	281	305	330	354	378	397
	250	136	163	190	217	229	256	283	310	337	365	392	419	446
<b>3,20</b>	89	134	162	190	213	240	268	296	319	347	375	402	430	453
	127	119	144	169	194	219	244	263	288	313	338	363	388	407
	250	140	168	197	225	236	264	292	320	349	377	405	433	461
<b>3,40</b>	89	138	166	195	218	247	275	304	327	356	384	413	441	464
	127	122	148	174	199	225	251	270	295	321	347	373	398	417
	250	145	174	203	232	244	273	302	331	360	389	418	446	475
<b>3,60</b>	89	141	170	200	223	253	282	311	335	364	394	423	452	476
	127	125	151	178	204	231	257	276	303	329	356	382	408	427
	250	150	180	210	239	251	281	311	341	371	401	430	460	490
<b>3,80</b>	89	145	175	205	229	259	289	319	343	373	403	433	464	488
	127	128	155	182	209	236	263	283	310	337	364	391	418	438
	250	154	185	216	247	258	289	320	351	382	413	443	474	505





ALTO \ ANCHO	LAMA	3,60	3,80	4,00	4,20	4,40	4,60	4,80	5,00	5,20	5,40	5,60	5,80	6,00
<b>1,00</b>	89	345	365	385	402	422	442	461	481	498	518	538	557	575
	127	311	329	347	365	382	397	415	433	451	468	486	501	519
	250	316	334	346	364	382	399	417	435	453	471	489	507	525
<b>1,20</b>	89	358	378	399	416	437	457	478	498	516	536	557	577	595
	127	322	341	359	378	396	411	430	448	467	485	503	519	537
	250	332	351	362	381	400	419	438	457	475	494	513	532	550
<b>1,40</b>	89	370	391	413	431	452	473	494	516	534	555	576	597	615
	127	333	352	371	391	410	425	444	463	483	502	521	536	555
	250	347	367	379	399	418	438	458	478	497	517	537	557	576
<b>1,60</b>	89	382	404	426	445	467	489	511	533	551	573	595	617	636
	127	344	364	384	404	423	439	459	479	498	518	538	554	573
	250	363	384	396	416	437	458	478	499	520	540	561	582	602
<b>1,80</b>	89	395	417	440	459	482	505	527	550	569	592	615	637	656
	127	355	376	396	416	437	453	473	494	514	535	555	571	592
	250	379	401	412	434	455	477	498	520	542	563	585	606	628
<b>2,00</b>	89	407	430	454	473	497	520	544	567	587	610	634	657	677
	127	366	387	408	429	451	467	488	509	530	551	573	589	610
	250	395	417	429	451	474	496	519	541	564	586	609	631	654
<b>2,20</b>	89	419	443	468	488	512	536	560	585	605	629	653	677	697
	127	377	399	421	442	464	481	503	525	546	568	590	607	628
	250	410	434	445	469	492	516	539	563	586	609	633	656	680
<b>2,40</b>	89	431	457	481	502	527	552	577	602	622	647	672	697	718
	127	388	411	433	455	478	495	517	540	562	585	607	624	647
	250	426	450	462	486	511	535	559	584	608	633	657	681	706
<b>2,60</b>	89	444	470	495	516	542	568	593	619	640	666	691	717	738
	127	399	422	445	468	491	509	532	555	578	601	624	642	665
	250	442	467	479	504	529	554	580	605	630	656	681	706	731
<b>2,80</b>	89	456	483	509	531	557	583	610	636	658	684	711	737	758
	127	410	434	458	481	505	523	547	570	594	618	642	659	683
	250	457	484	495	521	548	574	600	626	653	679	705	731	757
<b>3,00</b>	89	468	496	523	545	572	599	626	653	675	703	730	757	779
	127	421	445	470	494	519	537	561	586	610	635	659	677	701
	250	473	500	512	539	566	593	620	648	675	702	729	756	783
<b>3,20</b>	89	481	509	537	559	587	615	643	671	693	721	749	777	799
	127	432	457	482	507	532	551	576	601	626	651	676	695	720
	250	489	517	529	557	585	613	641	669	697	725	753	781	809
<b>3,40</b>	89	493	522	550	573	602	631	659	688	711	740	768	797	820
	127	443	469	494	520	546	565	590	616	642	668	693	712	738
	250	504	533	545	574	603	632	661	690	719	748	777	806	835
<b>3,60</b>	89	505	535	564	588	617	646	676	705	729	758	787	817	840
	127	454	480	507	533	560	579	605	632	658	684	711	730	756
	250	520	550	562	592	622	651	681	711	741	771	801	831	861
<b>3,80</b>	89	518	548	578	602	632	662	692	722	746	776	807	837	861
	127	465	492	519	546	573	593	620	647	674	701	728	747	775
	250	536	567	578	609	640	671	702	733	763	794	825	856	886



TARIFA CV-03

TENDENCE, JUNO, CETUS, SPS-4155, JUPITER

ALTO \ ANCHO	LAMA	1,00	1,20	1,40	1,60	1,80	2,00	2,20	2,40	2,60	2,80	3,00	3,20	3,40
<b>1,00</b>	89	99	119	140	157	178	198	218	236	256	277	297	317	335
	127	89	107	126	144	163	181	196	215	233	252	270	288	303
	250	91	109	128	146	158	176	194	212	231	249	267	285	303
<b>1,20</b>	89	103	124	145	164	185	206	227	245	266	288	309	330	348
	127	93	112	131	150	169	189	204	223	243	262	281	300	316
	250	96	115	135	154	166	185	204	223	242	262	281	300	319
<b>1,40</b>	89	107	129	151	170	192	214	236	254	277	299	321	343	361
	127	96	116	136	156	176	196	212	232	252	272	292	312	328
	250	101	121	142	162	173	194	214	234	254	274	295	315	335
<b>1,60</b>	89	111	134	157	176	199	222	245	264	287	310	333	355	375
	127	100	120	141	162	183	204	220	241	262	282	303	324	340
	250	106	127	148	170	181	202	224	245	266	287	308	329	351
<b>1,80</b>	89	115	139	162	182	206	230	253	273	297	321	344	368	388
	127	103	125	146	168	189	211	228	249	271	293	314	336	352
	250	111	133	155	177	189	211	233	256	278	300	322	344	366
<b>2,00</b>	89	119	143	168	188	213	238	262	282	307	332	356	381	401
	127	107	129	152	174	196	219	236	258	280	303	325	347	365
	250	116	139	162	185	197	220	243	266	290	313	336	359	382
<b>2,20</b>	89	123	148	174	195	220	245	271	292	317	343	368	394	414
	127	110	133	157	180	203	226	243	267	290	313	336	359	377
	250	121	145	169	193	205	229	253	277	301	326	350	374	398
<b>2,40</b>	89	127	153	179	201	227	253	280	301	328	354	380	406	428
	127	114	138	162	186	210	233	251	275	299	323	347	371	389
	250	126	151	176	201	213	238	263	288	313	338	363	389	414
<b>2,60</b>	89	131	158	185	207	234	261	288	310	338	365	392	419	441
	127	117	142	167	192	216	241	259	284	309	333	358	383	401
	250	131	157	183	209	221	247	273	299	325	351	377	403	429
<b>2,80</b>	89	135	163	191	213	241	269	297	320	348	376	404	432	454
	127	121	146	172	197	223	248	267	293	318	344	369	395	413
	250	136	163	190	217	229	256	283	310	337	364	391	418	445
<b>3,00</b>	89	139	167	196	220	248	277	306	329	358	387	416	445	468
	127	124	151	177	203	230	256	275	301	328	354	380	407	426
	250	140	169	197	225	236	264	293	321	349	377	405	433	461
<b>3,20</b>	89	143	172	202	226	255	285	315	339	368	398	428	457	481
	127	128	155	182	209	236	263	283	310	337	364	391	418	438
	250	145	174	204	233	244	273	302	331	361	390	419	448	477
<b>3,40</b>	89	147	177	208	232	263	293	324	348	379	409	440	470	494
	127	132	159	187	215	243	271	291	319	347	374	402	430	450
	250	150	180	210	240	252	282	312	342	372	402	432	462	492
<b>3,60</b>	89	151	182	213	238	270	301	332	357	389	420	451	483	508
	127	135	164	192	221	250	278	299	327	356	385	413	442	462
	250	155	186	217	248	260	291	322	353	384	415	446	477	508
<b>3,80</b>	89	155	187	219	245	277	309	341	367	399	431	463	495	521
	127	139	168	198	227	256	286	307	336	365	395	424	454	474
	250	160	192	224	256	268	300	332	364	396	428	460	492	524



ALTO \ ANCHO	LAMA	3,60	3,80	4,00	4,20	4,40	4,60	4,80	5,00	5,20	5,40	5,60	5,80	6,00
<b>1,00</b>	89	355	375	396	413	434	454	474	495	512	532	553	573	591
	127	322	340	359	377	396	411	429	448	466	484	503	518	536
	250	322	340	352	370	388	406	424	443	461	479	497	515	534
<b>1,20</b>	89	369	390	412	430	451	472	493	514	533	554	575	596	614
	127	335	354	373	393	412	427	446	466	485	504	523	539	558
	250	338	358	369	388	408	427	446	465	484	504	523	542	561
<b>1,40</b>	89	383	405	427	446	468	490	512	534	553	575	597	619	638
	127	348	368	388	408	428	444	464	484	504	524	544	560	580
	250	355	375	387	407	427	447	468	488	508	528	548	569	589
<b>1,60</b>	89	397	420	443	462	485	508	531	554	573	596	619	642	661
	127	361	382	403	423	444	460	481	502	523	544	564	581	601
	250	372	393	405	426	447	468	489	511	532	553	574	595	616
<b>1,80</b>	89	412	435	459	479	503	526	550	574	594	617	641	665	685
	127	374	396	417	439	460	477	498	520	542	563	585	601	623
	250	388	411	422	445	467	489	511	533	555	578	600	622	644
<b>2,00</b>	89	426	450	475	495	520	544	569	594	614	639	663	688	708
	127	387	409	432	454	476	493	516	538	561	583	605	622	645
	250	405	428	440	463	486	510	533	556	579	602	625	648	671
<b>2,20</b>	89	440	465	491	512	537	563	588	614	634	660	685	711	732
	127	400	423	446	469	492	510	533	556	579	603	626	643	666
	250	422	446	458	482	506	530	554	579	603	627	651	675	699
<b>2,40</b>	89	454	480	507	528	554	581	607	633	655	681	707	734	755
	127	413	437	461	485	509	526	550	574	598	622	646	664	688
	250	439	464	476	501	526	551	576	601	626	651	676	702	727
<b>2,60</b>	89	468	495	523	545	572	599	626	653	675	702	729	757	779
	127	426	451	475	500	525	543	568	593	617	642	667	685	710
	250	455	482	493	519	545	572	598	624	650	676	702	728	754
<b>2,80</b>	89	482	510	538	561	589	617	645	673	696	724	751	779	802
	127	439	464	490	515	541	560	585	611	636	662	687	706	731
	250	472	499	511	538	565	592	619	646	674	701	728	755	782
<b>3,00</b>	89	496	525	554	577	606	635	664	693	716	745	774	802	826
	127	452	478	505	531	557	576	602	629	655	681	708	727	753
	250	489	517	529	557	585	613	641	669	697	725	753	781	809
<b>3,20</b>	89	511	540	570	594	623	653	683	713	736	766	796	825	849
	127	465	492	519	546	573	593	620	647	674	701	728	748	775
	250	506	535	547	576	605	634	663	692	721	750	779	808	837
<b>3,40</b>	89	525	555	586	610	641	671	702	732	757	787	818	848	873
	127	478	506	534	562	589	609	637	665	693	721	749	768	796
	250	522	553	564	594	624	654	684	714	744	774	804	834	864
<b>3,60</b>	89	539	570	602	627	658	689	721	752	777	808	840	871	896
	127	491	520	548	577	606	626	654	683	712	740	769	789	818
	250	539	570	582	613	644	675	706	737	768	799	830	861	892
<b>3,80</b>	89	553	585	618	643	675	707	740	772	797	830	862	894	919
	127	504	533	563	592	622	642	672	701	731	760	790	810	840
	250	556	588	600	632	664	696	728	760	792	824	856	888	920



TARIFA CV-04

CHEVRON, JUNO BLACKOUT, OPAC 487, B-SCREEN 1% - 3% - 5%

ALTO \ ANCHO	LAMA	1,00	1,20	1,40	1,60	1,80	2,00	2,20	2,40	2,60	2,80	3,00	3,20	3,40
<b>1,00</b>	89	105	126	148	167	188	210	231	250	271	293	314	336	354
	127	95	115	135	155	175	195	210	230	250	270	290	310	325
	250	101	121	141	161	173	193	213	233	253	273	293	313	333
<b>1,20</b>	89	110	133	155	174	197	220	242	262	284	307	330	352	371
	127	100	121	142	163	184	205	221	242	263	284	305	325	342
	250	107	129	150	172	183	205	226	248	269	290	312	333	355
<b>1,40</b>	89	115	139	163	182	206	230	254	274	297	321	345	369	388
	127	105	127	149	171	193	215	232	253	276	297	319	341	358
	250	114	137	160	182	194	217	240	262	285	308	331	353	376
<b>1,60</b>	89	120	145	170	190	215	240	265	285	310	335	360	385	405
	127	110	133	156	179	202	225	242	265	288	311	334	357	375
	250	121	145	169	193	205	229	253	277	301	325	349	373	398
<b>1,80</b>	89	125	151	177	198	224	250	276	297	324	349	375	401	423
	127	114	138	163	187	211	235	253	277	301	325	349	373	391
	250	127	153	178	204	216	241	266	292	317	343	368	394	419
<b>2,00</b>	89	130	157	184	206	233	260	287	309	337	364	391	418	440
	127	119	144	170	195	220	245	263	288	314	339	364	389	407
	250	134	161	188	215	226	253	280	307	333	360	387	414	441
<b>2,20</b>	89	135	163	192	214	243	271	299	321	350	378	406	434	457
	127	124	150	176	203	229	255	274	300	326	353	379	405	424
	250	141	169	197	225	237	265	293	321	350	378	406	434	462
<b>2,40</b>	89	140	170	199	222	252	281	310	333	363	392	421	450	474
	127	129	156	183	211	238	265	284	312	339	366	393	421	440
	250	148	177	207	236	248	277	307	336	366	395	425	454	483
<b>2,60</b>	89	146	176	206	230	261	291	321	345	376	406	436	467	491
	127	133	162	190	218	247	275	295	323	352	380	408	437	457
	250	154	185	216	247	258	289	320	351	382	413	443	474	505
<b>2,80</b>	89	151	182	214	238	270	301	333	357	389	420	452	483	508
	127	138	168	197	226	256	285	306	335	364	394	423	452	473
	250	161	193	225	257	269	301	333	366	398	430	462	494	526
<b>3,00</b>	89	156	188	221	246	279	311	344	369	402	434	467	499	525
	127	143	173	204	234	265	295	316	347	377	408	438	468	489
	250	168	201	235	268	280	313	347	380	414	447	481	514	548
<b>3,20</b>	89	161	194	228	254	288	321	355	381	415	449	482	516	542
	127	148	179	211	242	274	305	327	358	390	421	453	484	506
	250	174	209	244	279	291	325	360	395	430	465	500	534	569
<b>3,40</b>	89	166	201	235	262	297	332	366	393	428	463	497	532	559
	127	153	185	218	250	283	315	337	370	403	435	468	500	522
	250	181	217	254	290	301	338	374	410	446	482	518	555	591
<b>3,60</b>	89	171	207	243	270	306	342	378	405	441	477	513	548	576
	127	157	191	225	258	292	325	348	382	415	449	482	516	539
	250	188	225	263	300	312	350	387	425	462	500	537	575	612
<b>3,80</b>	89	176	213	250	278	315	352	389	417	454	491	528	565	593
	127	162	197	231	266	301	335	359	393	428	463	497	532	555
	250	194	233	272	311	323	362	401	439	478	517	556	595	634



ALTO \ ANCHO	LAMA	3,60	3,80	4,00	4,20	4,40	4,60	4,80	5,00	5,20	5,40	5,60	5,80	6,00
<b>1,00</b>	89	376	398	419	437	459	481	502	524	542	564	585	607	625
	127	345	365	385	405	425	440	460	480	500	520	540	555	575
	250	353	373	385	405	425	445	465	486	506	526	546	566	586
<b>1,20</b>	89	394	417	439	459	481	504	527	549	568	591	614	636	655
	127	363	384	405	425	446	463	484	505	525	546	567	583	604
	250	376	398	409	431	452	473	495	516	538	559	581	602	623
<b>1,40</b>	89	412	436	460	480	503	527	551	575	595	618	642	666	686
	127	380	402	424	446	468	485	507	529	551	573	595	612	633
	250	399	422	433	456	479	502	524	547	570	593	615	638	661
<b>1,60</b>	89	430	455	480	501	525	550	575	600	621	645	670	695	716
	127	398	421	444	467	490	507	530	553	576	599	622	640	663
	250	422	446	458	482	506	530	554	578	602	626	650	674	699
<b>1,80</b>	89	448	475	500	522	548	574	599	626	647	673	699	725	746
	127	415	439	463	487	511	529	553	578	602	626	650	668	692
	250	444	470	482	507	533	558	583	609	634	660	685	711	736
<b>2,00</b>	89	467	494	521	543	570	597	624	651	673	700	727	754	776
	127	433	458	483	508	533	552	577	602	627	652	677	696	721
	250	467	494	506	533	559	586	613	640	667	693	720	747	774
<b>2,20</b>	89	485	513	541	564	592	620	648	676	699	727	755	783	806
	127	450	476	502	529	555	574	600	626	652	679	705	724	750
	250	490	518	530	558	586	614	642	671	699	727	755	783	811
<b>2,40</b>	89	503	532	561	585	614	643	672	702	725	754	784	813	836
	127	467	495	522	549	576	596	623	651	678	705	732	752	779
	250	513	542	554	584	613	643	672	702	731	760	790	819	849
<b>2,60</b>	89	521	552	582	606	636	667	697	727	751	782	812	842	866
	127	485	513	542	570	598	618	647	675	703	731	760	780	808
	250	536	567	578	609	640	671	701	732	763	794	825	856	886
<b>2,80</b>	89	539	571	602	627	658	690	721	753	777	809	840	872	896
	127	502	532	561	591	620	640	670	699	729	758	787	808	837
	250	558	591	602	635	667	699	731	763	795	828	860	892	924
<b>3,00</b>	89	557	590	622	648	681	713	745	778	804	836	869	901	927
	127	520	550	581	611	642	663	693	724	754	784	815	836	866
	250	581	615	627	660	694	727	760	794	828	861	895	928	961
<b>3,20</b>	89	576	609	643	669	703	736	770	803	830	863	897	930	957
	127	537	569	600	632	663	685	716	748	779	811	842	864	895
	250	604	639	651	686	720	755	790	825	860	895	929	964	999
<b>3,40</b>	89	594	628	663	690	725	759	794	829	856	891	925	960	987
	127	555	587	620	652	685	707	740	772	805	837	870	892	925
	250	627	663	675	711	747	783	820	856	892	928	964	1000	1037
<b>3,60</b>	89	612	648	683	711	747	783	818	854	882	918	954	989	1017
	127	572	606	640	673	707	729	763	797	830	864	897	920	954
	250	650	687	699	737	774	812	849	887	924	962	999	1037	1074
<b>3,80</b>	89	630	667	704	732	769	806	843	880	908	945	982	1019	1047
	127	590	624	659	694	728	752	786	821	856	890	925	948	983
	250	673	712	723	762	801	840	879	918	956	995	1034	1073	1112





TARIFA CV-05

CETUS SILVER, SUNSED, M-SCREEN 8505, NATURA

ALTO \ ANCHO	LAMA	1,00	1,20	1,40	1,60	1,80	2,00	2,20	2,40	2,60	2,80	3,00	3,20	3,40
<b>1,00</b>	89	115	139	163	183	207	230	254	274	298	322	345	369	389
	127	104	126	148	170	192	213	230	252	274	296	318	339	356
	250	105	126	147	168	180	201	222	243	264	285	306	327	348
<b>1,20</b>	89	122	148	173	194	219	244	270	291	316	341	367	392	413
	127	111	134	157	181	204	227	245	268	291	315	338	361	379
	250	113	135	158	180	192	214	237	259	282	304	327	349	372
<b>1,40</b>	89	129	156	183	205	232	259	285	307	334	361	388	415	436
	127	117	142	167	191	216	241	259	284	309	333	358	383	401
	250	120	144	168	192	204	228	252	276	300	324	348	372	396
<b>1,60</b>	89	136	165	193	216	244	273	301	324	352	381	409	437	460
	127	124	150	176	202	228	255	274	300	326	352	378	404	423
	250	128	153	179	204	216	242	267	293	318	344	369	395	420
<b>1,80</b>	89	144	173	203	227	257	287	317	341	371	400	430	460	484
	127	130	158	186	213	241	268	288	315	343	371	398	426	446
	250	135	162	190	217	228	255	282	309	336	363	390	417	444
<b>2,00</b>	89	151	182	213	238	270	301	332	357	389	420	451	483	508
	127	137	166	195	224	253	282	302	331	360	389	418	447	468
	250	143	171	200	229	240	269	297	326	355	383	412	440	469
<b>2,20</b>	89	158	191	224	249	282	315	348	374	407	440	473	505	531
	127	143	174	204	235	265	296	317	347	378	408	439	469	490
	250	150	181	211	241	252	282	313	343	373	403	433	463	493
<b>2,40</b>	89	165	199	234	260	295	329	364	391	425	459	494	528	555
	127	150	182	214	245	277	309	331	363	395	427	459	491	513
	250	158	190	221	253	265	296	328	359	391	422	454	486	517
<b>2,60</b>	89	172	208	244	272	307	343	379	407	443	479	515	551	579
	127	156	189	223	256	290	323	346	379	412	446	479	512	535
	250	166	199	232	265	277	310	343	376	409	442	475	508	541
<b>2,80</b>	89	179	216	254	283	320	358	395	424	461	499	536	574	603
	127	163	197	232	267	302	337	360	395	430	464	499	534	557
	250	173	208	243	277	289	323	358	393	427	462	496	531	566
<b>3,00</b>	89	186	225	264	294	333	372	411	440	480	518	557	596	626
	127	169	205	242	278	314	350	374	411	447	483	519	555	579
	250	181	217	253	289	301	337	373	409	445	482	518	554	590
<b>3,20</b>	89	193	233	274	305	345	386	426	457	498	538	579	619	650
	127	176	213	251	289	326	364	389	426	464	502	539	577	602
	250	188	226	264	301	313	351	388	426	464	501	539	576	614
<b>3,40</b>	89	200	242	284	316	358	400	442	474	516	558	600	642	674
	127	182	221	260	299	339	378	403	442	481	521	560	599	624
	250	196	235	274	313	325	364	403	442	482	521	560	599	638
<b>3,60</b>	89	207	251	294	327	371	414	457	490	534	578	621	664	697
	127	189	229	270	310	351	391	418	458	499	539	580	620	646
	250	203	244	285	326	337	378	418	459	500	541	581	622	662
<b>3,80</b>	89	214	259	304	338	383	428	473	507	552	597	642	687	721
	127	195	237	279	321	363	405	432	474	516	558	600	642	669
	250	211	253	295	338	349	391	434	476	518	560	602	645	687



ALTO \ ANCHO	LAMA	3,60	3,80	4,00	4,20	4,40	4,60	4,80	5,00	5,20	5,40	5,60	5,80	6,00
<b>1,00</b>	89	413	437	461	480	504	528	552	576	595	619	643	667	687
	127	378	400	422	444	465	482	504	526	548	570	591	608	630
	250	369	390	401	422	443	464	485	506	527	548	569	590	611
<b>1,20</b>	89	438	464	489	510	535	560	586	611	632	657	682	708	729
	127	402	425	448	472	495	513	536	559	582	606	629	646	670
	250	394	417	429	451	474	496	518	541	564	586	608	631	653
<b>1,40</b>	89	463	490	517	539	566	593	619	646	668	695	722	749	770
	127	426	450	475	500	524	543	567	592	617	642	666	685	709
	250	420	444	456	480	504	528	552	576	600	624	648	672	696
<b>1,60</b>	89	489	517	545	568	596	625	653	682	704	733	761	789	812
	127	449	476	502	528	554	573	599	625	652	678	704	723	749
	250	446	471	483	509	534	560	585	611	636	662	687	713	738
<b>1,80</b>	89	514	544	574	597	627	657	687	717	741	771	800	830	854
	127	473	501	528	556	584	603	631	659	686	714	741	761	788
	250	471	499	510	537	564	591	618	646	673	700	727	754	781
<b>2,00</b>	89	539	570	602	627	658	689	721	752	777	808	840	871	896
	127	497	526	555	584	613	633	662	692	721	750	779	799	828
	250	497	526	538	566	595	623	652	680	709	737	766	794	823
<b>2,20</b>	89	564	597	630	656	689	722	755	788	813	846	879	912	938
	127	521	551	582	612	643	664	694	725	755	786	816	837	868
	250	523	553	565	595	625	655	685	715	745	775	805	835	865
<b>2,40</b>	89	589	624	658	685	720	754	788	823	850	884	919	953	980
	127	544	576	608	640	672	694	726	758	790	822	854	875	907
	250	549	580	592	624	655	687	718	750	782	813	845	876	908
<b>2,60</b>	89	615	651	687	715	750	786	822	858	886	922	958	994	1022
	127	568	602	635	668	702	724	758	791	824	858	891	914	947
	250	574	608	619	652	685	719	752	785	818	851	884	917	950
<b>2,80</b>	89	640	677	715	744	781	819	856	894	922	960	997	1035	1064
	127	592	627	662	696	731	754	789	824	859	894	928	952	986
	250	600	635	647	681	716	750	785	820	854	889	923	958	993
<b>3,00</b>	89	665	704	743	773	812	851	890	929	959	998	1037	1076	1105
	127	616	652	688	724	761	785	821	857	893	930	966	990	1026
	250	626	662	674	710	746	782	818	854	891	927	963	999	1035
<b>3,20</b>	89	690	731	771	802	843	883	924	964	995	1036	1076	1116	1147
	127	639	677	715	753	790	815	853	890	928	966	1003	1028	1066
	250	652	689	701	739	776	814	852	889	927	964	1002	1040	1077
<b>3,40</b>	89	716	758	800	832	874	915	957	1000	1031	1073	1115	1157	1189
	127	663	702	742	781	820	845	884	923	963	1002	1041	1066	1105
	250	677	717	728	767	807	846	885	924	963	1002	1041	1081	1120
<b>3,60</b>	89	741	784	828	861	904	948	991	1035	1068	1111	1155	1198	1231
	127	687	728	768	809	849	875	916	957	997	1038	1078	1104	1145
	250	703	744	756	796	837	877	918	959	1000	1040	1081	1121	1162
<b>3,80</b>	89	766	811	856	890	935	980	1025	1070	1104	1149	1194	1239	1273
	127	711	753	795	837	879	906	948	990	1032	1074	1116	1142	1184
	250	729	771	783	825	867	909	951	994	1036	1078	1120	1162	1204



## INTRODUCCIÓN

PERSAX® ofrece el Panel Deslizante en tres versiones, accionamiento a cordón, a varilla y motorizado, pudiéndose fabricar con rieles de 2, 3, 4 ó 5 vías. Todos los tejidos de nuestro catálogo, se pueden aplicar a estos sistemas, ello facilita crear ambientes, combinar diferentes texturas y acabados, dándole su toque personal.

Sus diferentes tipologías de apertura, y la posibilidad de instalar dos rieles junto, permiten cubrir hasta 12 metros lineales, siendo así un producto perfecto para dividir espacios. Además también aquí, ofrecemos la posibilidad mediante impresión digital, de personalizar su cortina, haciéndola única.



## MEDIDAS MÁXIMAS Y MÍNIMAS A FABRICAR

SISTEMA	ANCHO MÍNIMO	ANCHO MÁXIMO	ALTO MÍNIMO	ALTO MÁXIMO
<b>Sistema Élite</b>	Sin mínimo	550 cm	Sin mínimo	320 cm

## ACCESORIOS DE INSTALACIÓN (Sin cargo. Incluidos en el precio de la cortina)

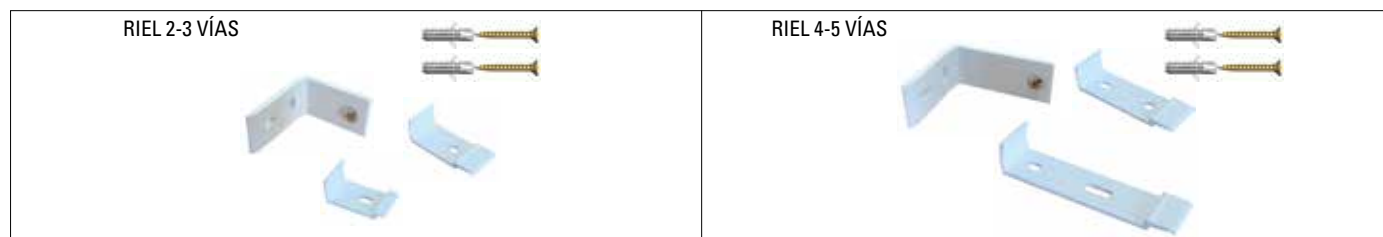
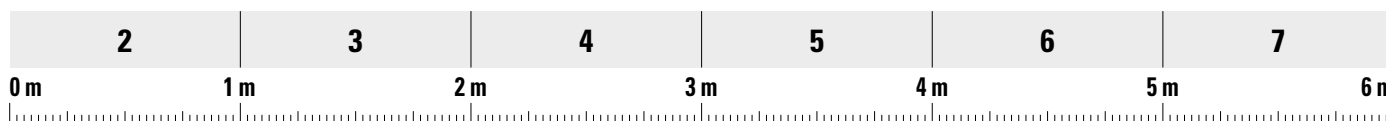

## DATOS NECESARIOS PARA REALIZAR UN PEDIDO

ARTÍCULO	TEJIDOS TÉCNICOS	TEJIDOS DECORATIVOS	TEJIDOS OPACOS
	Referencia Color	Referencia Color	Referencia Color
MEDIDAS	Ancho X Alto		
ACCIONAMIENTOS	Cordón	Motor ↑	Varilla ↑
MANDOS	Izquierda	Derecha	
DISPOSICIÓN DE PANELES	Ver disposición de paneles en la página 54		
ESCUADRAS	Ver incrementos en página 64		
<b>Facturación: Precio Riel + Precio Paneles = Precio Panel Deslizante</b>			

↑ Incremento de precio

## TARIFA DE PRECIOS - RIEL ÉLITE

VÍAS / ANCHO	CÓDIGO	1,00	1,50	2,00	2,50	3,00	3,50	4,00	4,50	5,00	5,50	
2 VÍAS	Cordón	237005	86	105	117	140	160	178	197	210	236	257
	Motor	237007	505	522	539	557	588	608	626	654	671	684
3 VÍAS	Cordón	237006	123	129	142	160	178	201	220	247	268	287
	Motor	237008	135	154	172	191	206	245	266	287	314	335
4 VÍAS	Cordón	237009	517	533	551	575	598	631	652	683	702	716
	Motor	237010	172	191	203	223	250	265	286	320	343	364
5 VÍAS	Cordón	237011	535	544	565	590	615	639	662	711	729	743
	Motor											



## SEGURIDAD INFANTIL

SEGURIDAD INFANTIL	CÓDIGO	DESCRIPCIÓN	PRECIO € / und.
	119055	SOPORTE RECOGEDOR CORDÓN	3,10
	119059	TENSOR CORDÓN / CADENA	3,40

## INCREMENTO ACCESORIOS MOTORIZACIÓN - RIEL ÉLITE

	CÓDIGO	DESCRIPCIÓN	PRECIO € / UNIDAD
	-	M. DISTANCIA 5 CANALES	170,40
	-	TRANSFORMADOR	56,40

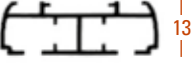
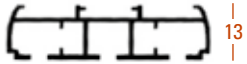
DISPOSICIÓN DE LOS RIELES - SISTEMA ÉLITE

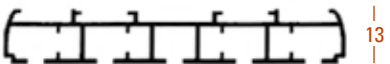
RIELES	REFERENCIAS DISPOSICIÓN																																
<p><b>2 VÍAS</b></p> <p>SISTEMA ÉLITE</p> <p>38</p> 	<table border="0"> <tr> <td>201</td><td></td> <td>202</td><td></td> </tr> <tr> <td>203</td><td></td> <td>204</td><td></td> </tr> <tr> <td>205</td><td></td> <td>206</td><td></td> </tr> <tr> <td>207</td><td></td> <td>208</td><td></td> </tr> <tr> <td>209</td><td></td> <td>210</td><td></td> </tr> </table>	201		202		203		204		205		206		207		208		209		210													
201		202																															
203		204																															
205		206																															
207		208																															
209		210																															
<p><b>3 VÍAS</b></p> <p>SISTEMA ÉLITE</p> <p>49</p> 	<table border="0"> <tr> <td>301</td><td></td> <td>302</td><td></td> </tr> <tr> <td>303</td><td></td> <td>304</td><td></td> </tr> <tr> <td>305</td><td></td> <td>306</td><td></td> </tr> <tr> <td>307</td><td></td> <td>308</td><td></td> </tr> <tr> <td>309</td><td></td> <td>310</td><td></td> </tr> <tr> <td>311</td><td></td> <td>312</td><td></td> </tr> </table>	301		302		303		304		305		306		307		308		309		310		311		312									
301		302																															
303		304																															
305		306																															
307		308																															
309		310																															
311		312																															
<p><b>4 VÍAS</b></p> <p>SISTEMA ÉLITE</p> <p>65,8</p> 	<table border="0"> <tr> <td>401</td><td></td> <td>402</td><td></td> <td>403</td><td></td> <td>404</td><td></td> </tr> <tr> <td>405</td><td></td> <td>406</td><td></td> <td>407</td><td></td> <td>408</td><td></td> </tr> <tr> <td>409</td><td></td> <td>410</td><td></td> <td>411</td><td></td> <td>412</td><td></td> </tr> <tr> <td>413</td><td></td> <td>414</td><td></td> <td></td><td></td> <td></td><td></td> </tr> </table>	401		402		403		404		405		406		407		408		409		410		411		412		413		414					
401		402		403		404																											
405		406		407		408																											
409		410		411		412																											
413		414																															
<p><b>5 VÍAS</b></p> <p>SISTEMA ÉLITE</p> <p>82,5</p> 	<table border="0"> <tr> <td>501</td><td></td> <td>502</td><td></td> <td>503</td><td></td> <td>504</td><td></td> </tr> <tr> <td></td><td></td> <td>505</td><td></td> <td>506</td><td></td> <td></td><td></td> </tr> <tr> <td>509</td><td></td> <td>510</td><td></td> <td>511</td><td></td> <td>512</td><td></td> </tr> <tr> <td>513</td><td></td> <td>514</td><td></td> <td>515</td><td></td> <td>516</td><td></td> </tr> </table>	501		502		503		504				505		506				509		510		511		512		513		514		515		516	
501		502		503		504																											
		505		506																													
509		510		511		512																											
513		514		515		516																											



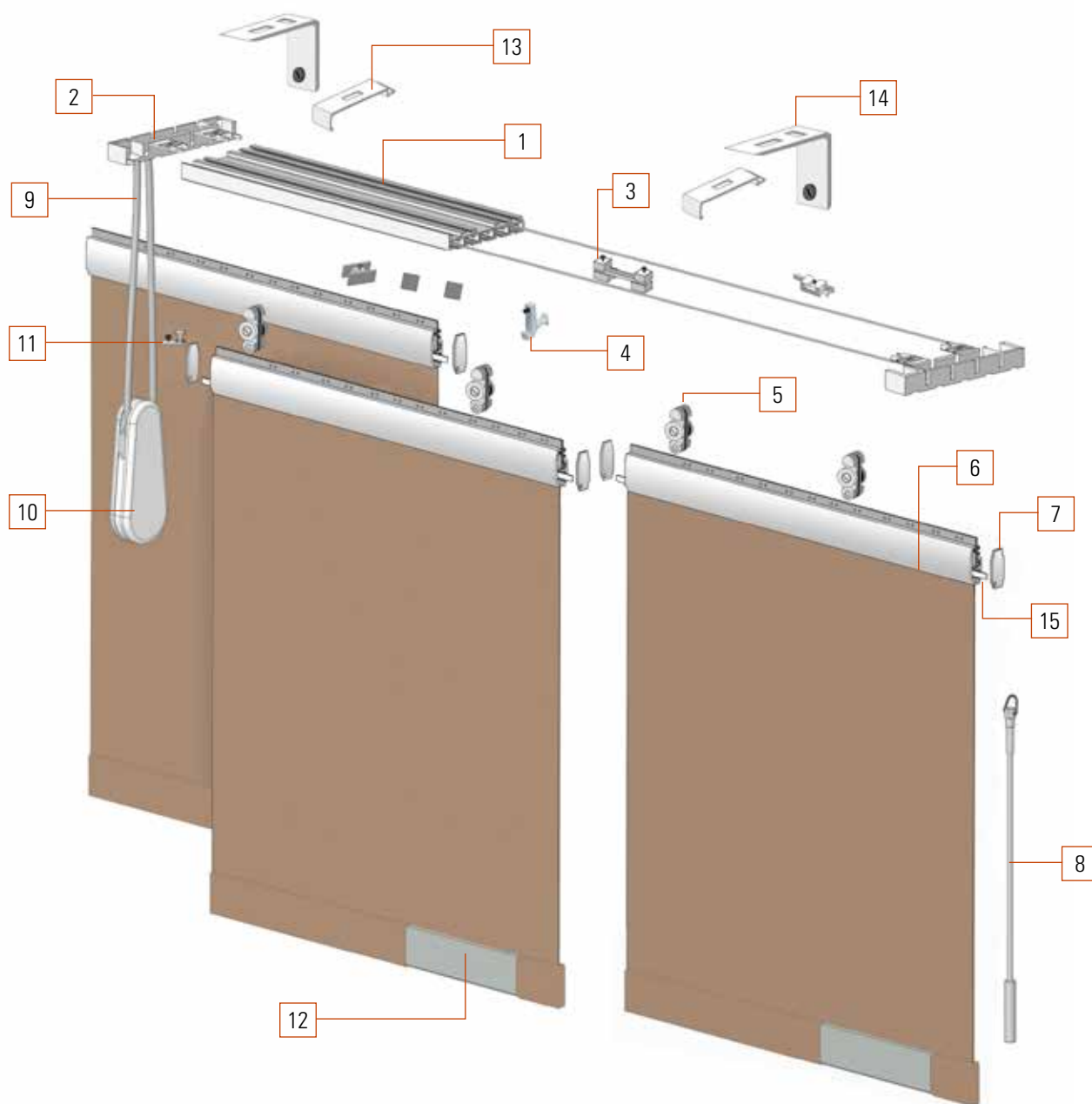























































**COMPONENTES - PANEL DESLIZANTE ÉLITE**



Nº	COMPONENTE	VÍAS	CÓDIGO
1	Riel vías Élite		-
2	Juego de tapas Riel Élite	2	137008
		3	137009
		4	137010
		5	137011
3	Trineo regulador Élite		137015
4	Final portatela "T" Élite		137007
5	Rodamiento portatela Élite		137012
6	Portatela Élite		337004
7	Tapa portatela izq.		137014
7	Tapa portatela der.		137013
8	Varilla mando 1,5 panel		137018

Nº	COMPONENTE	VÍAS	CÓDIGO
9	Cordón 2,7 mm blanco		337002
10	Pomo perita		118034
11	Final portatela "L" Élite		137016
12	Pletina aluminio 40 mm		337003
		2	137001
		3	137002
		4	137003
		5	137004
13	Clip techo panel	2-3	137005
		4-5	137006
14	Escuadra instalación riel		
15	Cinta fijación tejido panel		337001



GAMA		COMP.	 gr/m <sup>2</sup>	ANCHO	CARACTERÍSTICAS			TARIFA PRECIOS PANELES
<b>TEJIDOS EXCELLENCE</b>	BLACK-WHITE	100% PES	200	230 cm				<b>PD05</b>
	METAL LINE	PES / Luvex	120	280 cm				<b>PD04</b>
	AMARANT	100% PES	80	280 cm				<b>PD04</b>
	P. STITCH	Trevira CS	200	230 cm				<b>PD06</b>
	T. STITCH	100% PES	130	230 cm				<b>PD06</b>
<b>TEJIDOS DECORATIVOS</b>	TENDENCE	100% PES	130	230 cm				<b>PD02</b>
	JUNO	100% PES	160	230 cm				<b>PD02</b>
	CETUS	Trevira CS	140	230 cm				<b>PD02</b>
	CHEVRON	100% PES	240	230 cm				<b>PD03</b>
	JUPITER	Trevira CS	150	250 cm				<b>PD02</b>
	POLARIS	Trevira CS	200	230 cm				<b>PD01</b>
	MISSONI	100% PES	130	280 cm				<b>PD05</b>
	NATURA	Fibra V. / PVC	400	250 cm				<b>PD05</b>
	S-SCREEN	Fibra V. / PVC	630	310 cm				<b>PD06</b>
	CLASSIC	100% PES	220	300 cm				<b>PD01</b>
	RUSTIK	100% PES	180	300 cm				<b>PD01</b>
	SHANTUNG FR	100% PES	180	320 cm				<b>PD01</b>
<b>TEJIDOS OPACOS</b>	KARELLIS	100% PES	300	300 cm				<b>PD05</b>
	JUNO BLACK OUT	100% PES	280	230 cm				<b>PD03</b>
	TENDENCE BLACKOUT	100% PES	220	230 cm				<b>PD03</b>
	OPAC 487	Fibra V. / PVC	487	300 cm				<b>PD03</b>
<b>TEJIDOS TÉCNICOS</b>	SATINÉ 5500	Fibra V. / PVC	520	250 cm				<b>PD04</b>
	SPS-6053	PES / PVC	600	300 cm				<b>PD04</b>
	SPS-4155	PES / PVC	410	300 cm				<b>PD02</b>
	M-SCREEN 8505	Fibra V. / PVC	405	250 cm				<b>PD05</b>
	B-SCREEN 1%	Fibra V. / PVC	410	320 cm				<b>PD03</b>
	B-SCREEN 3%	Fibra V. / PVC	380	320 cm				<b>PD03</b>
	B-SCREEN 5%	Fibra V. / PVC	365	320 cm				<b>PD03</b>
	CETUS SIVER	Trevira CS	140	230 cm				<b>PD04</b>
	SUNSED	PES / PVC	420	300 cm				<b>PD04</b>
	POLIVISIÓN	100% PES	195	300 cm				<b>PD01</b>



**PRECIOS - PANEL CONFECCIONADO**

**TARIFA PD01**

ALTO \ ANCHO	0,60	0,80	1,00
<b>1,00</b>	25	27	29
<b>1,20</b>	25	27	32
<b>1,40</b>	25	29	36
<b>1,60</b>	25	32	39
<b>1,80</b>	26	34	42
<b>2,00</b>	28	37	45
<b>2,20</b>	30	39	48
<b>2,40</b>	32	42	51
<b>2,60</b>	34	44	54
<b>2,80</b>	36	47	58
<b>3,00</b>	38	49	61
<b>3,20</b>	40	52	64

**TARIFA PD02**

ALTO \ ANCHO	0,60	0,80	1,00
<b>1,00</b>	26	28	31
<b>1,20</b>	26	28	34
<b>1,40</b>	26	31	38
<b>1,60</b>	26	34	42
<b>1,80</b>	28	37	50
<b>2,00</b>	30	39	53
<b>2,20</b>	32	42	57
<b>2,40</b>	35	50	61
<b>2,60</b>	37	53	65
<b>2,80</b>	39	56	69
<b>3,00</b>	45	59	73
<b>3,20</b>	47	62	76

**TARIFA PD03**

ALTO \ ANCHO	0,60	0,80	1,00
<b>1,00</b>	33	35	38
<b>1,20</b>	33	35	43
<b>1,40</b>	33	38	47
<b>1,60</b>	33	42	52
<b>1,80</b>	35	46	57
<b>2,00</b>	38	50	62
<b>2,20</b>	41	54	67
<b>2,40</b>	44	58	71
<b>2,60</b>	47	62	76
<b>2,80</b>	50	65	81
<b>3,00</b>	53	69	86
<b>3,20</b>	56	73	91

**TARIFA PD04**

ALTO \ ANCHO	0,60	0,80	1,00
<b>1,00</b>	39	41	44
<b>1,20</b>	39	41	50
<b>1,40</b>	39	46	57
<b>1,60</b>	39	51	63
<b>1,80</b>	42	56	69
<b>2,00</b>	46	60	75
<b>2,20</b>	50	65	81
<b>2,40</b>	53	70	87
<b>2,60</b>	57	75	93
<b>2,80</b>	61	80	99
<b>3,00</b>	64	85	105
<b>3,20</b>	68	90	111

**TARIFA PD05**

ALTO \ ANCHO	0,60	0,80	1,00
<b>1,00</b>	44	46	49
<b>1,20</b>	44	46	56
<b>1,40</b>	44	51	63
<b>1,60</b>	44	57	70
<b>1,80</b>	47	62	77
<b>2,00</b>	51	68	84
<b>2,20</b>	56	73	91
<b>2,40</b>	60	79	97
<b>2,60</b>	64	84	104
<b>2,80</b>	68	90	111
<b>3,00</b>	72	95	118
<b>3,20</b>	76	101	125

**TARIFA PD06**

ALTO \ ANCHO	0,60	0,80	1,00
<b>1,00</b>	61	63	67
<b>1,20</b>	61	63	77
<b>1,40</b>	61	71	88
<b>1,60</b>	61	79	98
<b>1,80</b>	66	87	108
<b>2,00</b>	73	96	119
<b>2,20</b>	79	104	129
<b>2,40</b>	85	112	140
<b>2,60</b>	91	121	150
<b>2,80</b>	97	129	160
<b>3,00</b>	104	137	171
<b>3,20</b>	110	146	181



## INTRODUCCIÓN

Para el cliente que no le guste la estética de una cortina técnica sin más, PERSAX® ha creado una línea de galerías decorativas. Ya sea un panel deslizante, una cortina enrollable, una cortina vertical, ó cualquier cortina técnica, se puede mejorar su estética, añadiendo una galería que oculte los mecanismos.

Disponible en diferentes terminaciones como son el acabado en piel, metalizado, fibra natural ó madera, encontrará siempre la que busca.



## DIMENSIONES DE LA GALERÍA

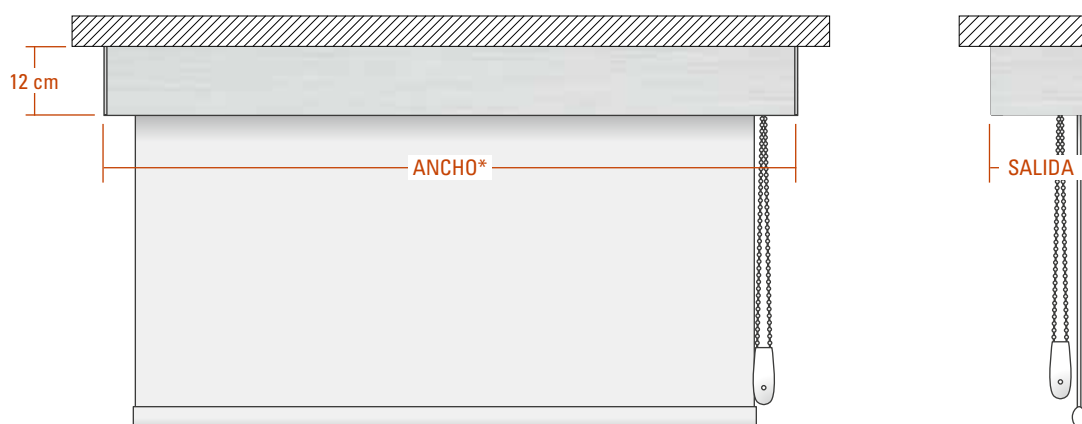

\* Ancho máximo en una pieza, 3,20 metros.

## DATOS NECESARIOS PARA REALIZAR UN PEDIDO

<b>ACABADO</b>	Referencia según carta de colores de "Galerías" (ver página siguiente)	
<b>MEDIDAS</b>	ANCHO x SALIDA (la altura SIEMPRE es 12 cm y la salida <b>ESTANDAR</b> es 12 cm)	
<b>SOPORTES</b>	PARED (escuadras, página 64) ↑	TECHO <b>ESTANDAR</b>

## PRECIOS

GALERIA COMPLETA	PRECIO € / m.l.
GRUPO 1	104,85
GRUPO 2	137,50

## INCREMENTOS POR PIEZAS ADICIONALES

ARTICULO	CODIGO	PRECIO € / unidad
TAPA FINAL GALERÍA	-	9,65
EMPALME CENTRAL PARA GALERÍA	-	5,25
SOPORTE TECHO GALERÍA (ADICIONAL)	-	0,50

\* Escuadras en página 64

**GAMA DE ACABADOS**

**GRUPO 1**

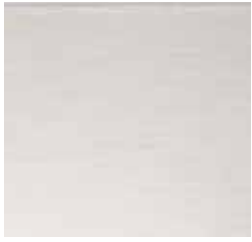

Metal Design 47814



Metallics 47374



Metallics 47380



Fine Wood 47289



Wood Grain 47632



Fine Wood 47255



Fine Wood 47315



Naturals 47547



Naturals 47546

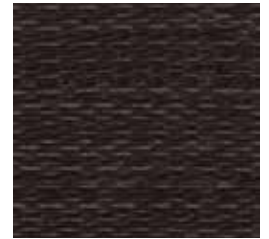

Straw 32532

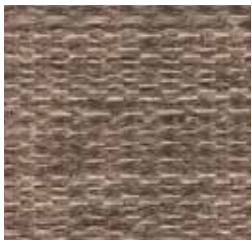

Straw 32533



Leather 32531



Naturals Sand 47337

**GRUPO 2**



Metal Design 47813



Metal Design 47804



Metal Design 47805

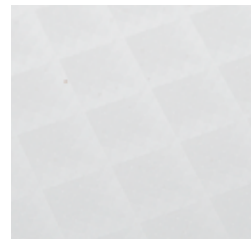

Metal Design 47806



Metal Design 47807



Metal Design 47808



Metal Design 47802

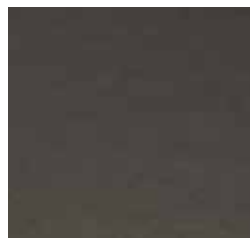

Metallics 47399



Metallics 47181

## INTRODUCCIÓN

La impresión digital es la mejor forma de personalizar una cortina.

Puede anunciar su empresa, expresar su gusto personal, su deporte favorito, su hobby, la foto de sus seres más queridos, todo ello para hacer más acogedor un espacio ó para llamar la atención.

En PERSAX® disponemos de los medios para hacer de su cortina una obra de arte. Elija una imagen de cualquier depósito de fotos disponible en Internet, nosotros la compramos con la calidad necesaria para obtener los mejores resultados. Si por lo contrario es usted quien aporta la imagen debe tener en cuenta las siguientes consideraciones:



## IMPRESIÓN DE LOGOTIPOS E IMÁGENES

### REQUISITOS TÉCNICOS

El logotipo ha de estar preferiblemente en formato VECTORIAL, esto es en PDF, Adobe Illustrator o Corel Draw. Con este sencillo requisito conseguiremos unos resultados de calidad excepcionales.

También se puede facilitar un logotipo en formato IMAGEN, pero este ha de tener necesariamente una resolución de 300 puntos por pulgada o 1 mb por m<sup>2</sup> y estar al tamaño real al que se ha de imprimir. En cuanto a los formatos de imagen aceptados se encuentran JPG, TIF, PSD o PNG. En caso de no cumplir con estos requisitos, la calidad del resultado final puede no ser del agrado del cliente.

Si el cliente desea imprimir una imagen de su propiedad en una cortina enrollable o un panel deslizante, ha de tener en cuenta los siguientes requisitos.

Toda imagen destinada a su impresión digital en un tejido ha de tener una resolución de 300 puntos por pulgada o un 1 mb por m<sup>2</sup> y estar al tamaño real al que se ha de imprimir. Es decir, que si la cortina mide 2 metros x 3 metros, la imagen debe de medir exactamente lo mismo. En cuanto a los formatos de imagen aceptados se encuentran JPG, TIF, PSD o PNG. En caso de no cumplir con estos requisitos, la calidad del resultado final puede no ser del agrado del cliente.

**ADVERTENCIA:** Tenga en cuenta que la impresión que realizamos es sobre fondo blanco, por lo que la elección de cualquier otro color distinto del blanco producirá resultados inesperados. Además, imprimir una imagen sobre fondo gris o negro no es posible.

## PRECIOS

ARTICULO	PRECIO UNIDAD	PRECIO € / m <sup>2</sup>
COMPRA DE IMAGEN PARA SU IMPRESIÓN	56,25	-
APLICACIÓN SOBRE TELA IMPRESIÓN DIGITAL	-	76,00
LOGOTIPOS Y ANAGRAMAS		52,00
RETOQUES ADICIONALES DE IMAGEN	60,00	-

**GALERÍA DE IMÁGENES (ejemplos)**

**PAISAJES**



**BAÑO**



**COCINAS**



**INFANTIL**



**DEPORTE**



**TENDENCIAS**



Si usted lo desea, puede proporcionarnos la imagen que desee de cualquier banco de imágenes de calidad disponibles en internet. Aquí le damos algunos ejemplos:

**DEPOSIT PHOTOS**

<http://sp.depositphotos.com/>

**ADOBE STOCK**

<http://stock.adobe.com/es/>

**iSTOCKPHOTO**

<http://www.istockphoto.com/es>







PERSAX<sup>®</sup>  
siente el espacio

Autovía A-31 (salida 191)  
Polígono Santa Eulalia  
03400 Villena (Alicante)  
ESPAÑA

T. 902 010 564  
F. 902 010 565  
ventas@persax.es

[www.persax.es](http://www.persax.es)